

PLANNING AND ZONING COMMISSION

AGENDA

Thursday, February 19, 2026, at 6:00 PM

City Hall, 1838 Emerald Hill Lane

Westminster, Maryland 21157

<https://www.youtube.com/@CityofWestminsterMD>

1. Call To Order
2. Approval Of Minute Summary
  - 2.I. Minutes

Documents:

[PZC MEETING MINUTES 12-17-2025.PDF](#)  
[PZC MEETING MINUTES 01-22-2026.PDF](#)

3. New Business

- 3.I. Item A: 2025 City Of Westminster Planning Annual Reporting Information Certification  
(A. Gerhard, DCPD)

Request: Introduction of the draft 2025 City of Westminster Planning Annual Reporting Information to the Commission and Carroll County Department of Planning.

Documents:

[ITEM A - 2025 COW PLANNING ANNUAL REPORT SR.PDF](#)  
[ATTACH 1 COW 2025 ANNUAL REPORT WORKSHEET.PDF](#)  
[ATTACH 2 COW PZC 2025 ANNUAL REPORT LETTER.PDF](#)

- 3.II. Item B: Final Resubdivision Plat, Chick-Fil-A (Mark Depo, DCPD)

Request: Resubdivide two parcels (SDAT# 07-029233 and 07-029241) located in the southeast quadrant of the Baltimore Blvd. (MD Route 140)/Old Baltimore Blvd. intersection to create new Lot 1 and Lot 2, to develop new Lot 1 with a Chick-fil-A restaurant, pursuant to the conditionally approved Site Development Plan S-23-0001.

Applicant: The Morgan Companies, c/o Scott Friedman, 4521 Sharon Road, Suite 275, Charlotte NC 28211

Owner: Baltimore Blvd Realty LLC, c/o Scott Friedman, 4521 Sharon Road, Suite 275, Charlotte NC 28211

Attorney: Kelly S. Miller, Shaffer and Shaffer LLP, 73 E Main Street, Westminster, MD 21157

Engineer: Daniel Haney, Bohler, 901 Dulaney Valley Road, Suite 801, Towson, MD 21204

Documents:

[ITEM B - FINAL RESUB PLAT CHICK-FIL-A PZC SR FINAL.PDF](#)  
[ATTACH 1 FINAL RESUBDIVISION PLAT CHICK-FIL-A.PDF](#)  
[ATTACH 2 MARKET ST ROW CC DEDICATION PLAT.PDF](#)

3.III. Item C: Sign Permit 2008, Boot Barn (Andrea Gerhard, DCPD)

Request: Construct two building mounted signs that are each greater than 64 square feet and up to but not exceeding 125 square feet in area as a tenant (Boot Barn) sign at 20 Englar Road, Westminster Shopping Center.

Applicant: Ryan Drury, Pacific Neon

Owner: Westminster Granite Main LLC

2838 Chain Bridge Road, NW

Washington, D.C, 20016

Documents:

[ITEM C - SIGN PERMIT NO. 2014 PZC SR.PDF](#)  
[ATTACH 1 SIGN PERMIT NO. 2014 BOOT BARN.PDF](#)

4. Old Business

4.I. Item D: Work Session On Zonal Map Amendment ZMA 24-01, The Willows Architectural Review (Mark Depo, DCPD)

Request: Zonal Map Amendment reclassifying certain real property from the R-7,500 Residential Zone to the Planned Development-9 Zone. The subject properties are identified by the State Department of Assessments and Taxation (SDAT) as #07-020430, #07-114443, #07-033338, #07-011490, #07-011482, #07-032471, #07-032455, and #07-044429 and located off and east of Pennsylvania Avenue and north of Sullivan Avenue. The applicant is proposing to construct 20 two-over-two dwellings for a total of 40 dwelling units.

Applicant: D.R. Acquisitions LLC

Owner: DASy Corporation, c/o Edward O. Bollinger, 52 Bachmans Valley Road, Westminster MD 21158-3108

Attorney: David K. Bowersox, Hoffman, Comfort, Offutt, Scott & Halstad LLP, 24 N Court Street, Westminster, MD 21157

Engineer: Martin Hacket, CLSI, 439 E Main Street, Westminster, MD 21157

Documents:

[ITEM D - ZMA 24-01 WILLOWS PD-9 PZC WS SR.PDF](#)

5. Information Item

5.I. Carroll County Liaison Report

6. Planning Commission Comments

7. Adjournment

8. Request For Decorum And Order

The Chair and Commissioners would like to thank you in advance for your respectful behavior and for your thoughtful consideration of the views of your neighbors, applicants, and the Commission. Members of the public attending meetings of the Planning and Zoning Commission are expected to maintain decorum and good order and to remain quiet when not recognized by the Chairperson. Any person who makes personal attacks or defamatory remarks, who makes loud comments when not recognized by the Chairperson, or who stamps his or her feet, whistles, yells, or engages in similarly disruptive conduct will be asked to leave. Persons who are asked to leave by the Chair and refuse to do so may be removed. Unauthorized remarks from the audience, stamping of feet, whistles, yells, and other similar demonstrations will not be permitted by the presiding officer. Offending parties will be asked to remove themselves from the meeting room.



**CITY OF WESTMINSTER  
PLANNING AND ZONING COMMISSION  
MEETING SUMMARY**

**Wednesday, December 17, 2025, at 6:00 p.m.**

**In-Person Meeting and broadcasted live on the City YouTube Channel**

**I. Call to Order**

A meeting of the City of Westminster Planning and Zoning Commission was held, and broadcast live on the City YouTube Channel, on Wednesday, December 17, 2025, at 6:00 p.m.

Chair Tom Beyard, Vice Chair Lyndi McNulty, Commissioner Kevin Beaver; Commissioner Jay Voight and Councilmember Hoff, Ex Officio were present. Director of Community Planning and Development Mark Depo and Senior Planner Andrea Gerhard, and Attorney Elson were also present.

Guests: Mr. Bryan Eberle, President of Construction with Obrecht Properties, LLC  
Mr. Tom Poss, President, Verdant Development Group

Chair Beyard opened the meeting at 6:00 p.m.

**II. Approval of Meeting Summary – February 20, 2025**

Chair Beyard requested a motion to approve the meeting summary of February 20, 2025. Commissioner Voight moved to approve the meeting summary of February 20, 2025. Vice Chair McNulty seconded the motion. The motion passed 5-0.

**Approval of Meeting Summary – September 18, 2025 – Closed Meeting**

Chair Beyard requested a motion to approve the Closed Meeting summary of September 18, 2025. Vice Chair McNulty moved to approve the Closed Meeting summary of September 18, 2025. Commissioner Beaver seconded the motion. The motion passed 5-0.

**III. New Business**

**Item A: Site Development Plan S-25-0006, 404 Malcolm Drive Medical Center**

Senior Planner Gerhard provided the staff report on Site Development Plan S-25-006, 404 Malcolm Drive Medical Center, noting that the applicant is requesting Site Development Plan approval to construct a 22,000 square foot medical center and a 12, 000 square foot building that will be used for either office space or a school/daycare at 404 Malcolm Drive. The Planning and Zoning Commissioners discussed the item at length. Senior Planner Gerhard

and Director of Community Planning and Development Depo responded to questions of clarifications given by the Commission on the item.

Mr. Bryan Eberle, President of Construction with Obrecht Properties, LLC, 9475 Deereco Road, Suite #200, Timonium, Maryland 21093, addressed the Planning and Zoning Commission in response to questions given by the Commission regarding the proposed project.

**Motion:** Councilmember Hoff, Ex Officio moved the City of Westminster Planning and Zoning Commission give conditional approval of the proposed Amended Site Plan S-25-0006, Malcolm Drive Medical Center with the following conditions of approval: (1) Provide a color-coded drawing that clearly depicts how the landscaping requirements of the Landscape Manual are being met; (2) Amend the façade of both medical office buildings to be more in compliance with the Design Preference Manual and to work with the City of Westminster Community Planning and Development staff on this item regarding the elevations of the project prior to coming back to the Planning and Zoning Commission for final approval at a future meeting; and (3) Address all remaining outstanding City and County comments prior to submission of signature set mylars . Commissioner Voight seconded the motion. The motion passed 5-0.

#### **Item B: Sign Permit No. 2008, Carroll County Board of Elections**

Senior Planner Gerhard provided the staff report on Sign Permit No. 2008, Carroll County Board of Elections noting that the applicant is requesting Sign Permit Application Approval for a sign that is greater than 64 square feet and up to but not exceeding 125 square feet as a tenant sign for 1101 Business Parkway South.

**Motion:** Commissioner Voight moved the City of Westminster Planning and Zoning Commission approve Sign Permit Application No. 2008 to allow a building mounted sign of 72.75 square feet for 1135 Business Parkway South, Westminster, Maryland. Vice Chair Lyndi McNulty seconded the motion. There was no discussion. The motion passed 5-0.

#### **IV. Old Business**

#### **Item C: Recommendation to Mayor and Common Council for Wakefield Valley Development Plan Amendment DP-24-01, Parcel W and Parcel X**

**Motion:** Councilmember Hoff, Ex Officio moved the City of Westminster Planning and Zoning Commission amend Westminster Planning and Zoning Commission Report and Recommendation regarding Wakefield Valley Development Plan Amendment DP-24-01, Parcels W and X (Revised) dated December 20, 2024 on Page 8 regarding the FINDING: The Planning Commission finds that the thirty-five (35) lots proposed are acceptable and in support of its finding states: with an amendment to (b) to read as follows: Other uses have been proposed for the Property that have not proven acceptable. Commissioner Voight seconded the motion. The motion passed 5-0.

Director of Community Planning and Development Depo provided the staff report on the recommendation to Mayor and Common Council for Wakefield Valley Development Plan Amendment DP-24-01, Parcel W and Parcel X, noting the amendment to Wakefield Valley Development Plan (the “2025 Development Plan”) to add 35 new density rights to Parcel W to construct 35 single-family detached dwelling units and dedicate Parcel X to Carroll Lutheran Village for open space. The Commission discussed the item at length.

**Motion:** Vice Chair McNulty moved that the City of Westminster Planning and Zoning Commission forward the Commission’s amended recommendation for DP-24-01 to the City of Westminster Mayor and Common Council. Commissioner Voight seconded the motion. The motion passed 5-0.

#### **Item D: Work Session on Zonal Map Amendment ZMA 24-01, The Willows**

Director of Community Planning and Development Depo provided an update on Zonal Map Amendment reclassifying certain real property from the R-7,500 Residential Zone to the Planned Development-9Zone. The Subject properties are identified by the State Department of Assessments and Taxation (SDAT) as #07-020430, #07-114443, #07-033338, #07-011490, #07-011482, #07-032471, #07-032455, and #07-044429 and located off and east of Pennsylvania Avenue and north of Sullivan Avenue. The applicant is proposing to construct 20 two-over-two dwellings for a total of 40 dwelling units. The Commission were provided with several building architectural elevation options, including updated rendering and photos of similar projects, by the Applicant. The Commission discussed the architectural elevations options at length. Senior Planner Gerhard and Director of Community Planning and Development Depo responded to question and provided clarification on the project and highlighted issues and noted concerns of the Department of Community Planning and Development. Mr. Tom Poss, representing the project, addressed the Commission’s comments and concerns about the proposed project. Director of Community Planning and Development Depo provided closing remarks on the item and the proposed next steps for the Planning and Zoning Commission.

#### **Carroll County Liaison Report**

Carlisle Fillat with Carroll County Planning Department was unable to attend the meeting. Ms. Fillat submitted information to the Commission regarding upcoming Carroll County projects.

#### **V. Planning Commission Comments**

The Commission discussed the January 2026 Planning and Zoning Commission next meeting. The Commission agreed to hold the meeting on Thursday, January 22, 2026, at 6:00 p.m.

#### **VI. Adjournment**

**Motion:** Chair Beyard requested a motion to adjourn the meeting. Commissioner Voight moved to adjourn the City of Westminster Planning and Zoning Meeting of December 17, 2025. Commissioner Beaver seconded the motion. The motion passed 5-0.

The meeting adjourned at 7:43 p.m.

---

Mr. Tom Beyard, Chair  
City of Westminster Planning and Zoning Commission

Official Recordings of the City of Westminster Planning and Zoning Commission are available for viewing in their entirety on the City's YouTube channel.

Adopted by the City of Westminster Planning and Zoning Commission on \_\_\_\_\_.

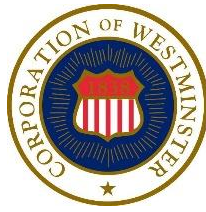

**CITY OF WESTMINSTER  
PLANNING AND ZONING COMMISSION  
MEETING SUMMARY**

**Thursday, January 22, 2026, at 6:00 p.m.**

**In-Person Meeting and broadcasted live on the City YouTube Channel**

**I. Call to Order**

A meeting of the City of Westminster Planning and Zoning Commission was held, and broadcast live on the City YouTube Channel, on Thursday, January 22, 2026, at 6:00 p.m.

Chair Tom Beyard, Vice Chair Lyndi McNulty, Commissioner Kevin Beaver; Commissioner Jay Voight, and Alternate Commissioner Tiombe Paige were present. Director of Community Planning and Development Mark Depo, Senior Planner Andrea Gerhard, Attorney Meredith McKinnion, and Doug Barber, City Clerk were also present. Councilmember Dan Hoff, Ex Officio, was absent.

Chair Beyard opened the meeting at 6:00 p.m.

**II. New Business**

**Item A: Public Hearing for Adoption of City of Westminster Chapter to the Water Resources Element Approval of Meeting Summary – February 20, 2025**

Chair Beyard opened the Public Hearing at 6:02 p.m. Senior Planner Gerhard provided the staff report on the adoption of the City of Westminster Chapter to the Water Resources Element. Senior Planner Gerhard responded to questions of clarification given by the Commission.

There was no one wishing to address the Planning and Zoning Commission.

Chair Beyard closed the Public Hearing at 6:07 p.m.

**Motion:** Commissioner Voight moved the City of Westminster Planning and Zoning Commission to provide the City of Westminster with a positive recommendation to adopt the City of Westminster Chapter to the Water Resources Element. Commissioner Beaver seconded the motion. There was no discussion. The motion passed, 5-0.

**Item B: Site Development Plan S-24-0031, William Winchester Elementary School Addition**

Senior Planner Gerhard provided the staff report on Site Development Plan S-24-0031, William Winchester Elementary School Addition, noting that the applicant is requesting Site Development Plan approval to construct a 1,9,55 square foot Pre-Kindergarten classroom

addition onto the existing elementary school at 60 and 70 Monroe Street, Westminster, Maryland 21157. Senior Planner Gerhard and Director of Community Planning and Development Depo responded to questions of clarifications given by the Commission on the item.

Mr. Jim Marks with the Carroll County Board of Education, addressed the Planning and Zoning Commission in response to questions given by the Commission regarding the proposed project.

**Motion:** Commissioner Voight moved the City of Westminster Planning and Zoning Commission to approve the conditional approval of Site Development Plan S-24-0031, William Winchester Elementary School addition, with the following conditions of approval: Address all outstanding City and County comments prior to submission of signature set mylars. Vice Chair McNulty seconded the motion. There was no discussion. The motion passed, 5-0.

### **Item C: Site Development Plan S-24-0032, Westminster Elementary School Addition**

Senior Planner Gerhard provided the staff report on Site Development Plan S-24-0032, Westminster Elementary School Addition, noting that the applicant is requesting Site Development Plan approval to construct two additions for a Pre-Kindergarten and Instrumental Music classroom addition into the existing elementary school totaling 3,333 square feet at 811 Uniontown Road, Westminster Maryland. Senior Planner Gerhard and Director of Community Planning and Development Depo responded to questions of clarifications given by the Commission on the item.

Mr. Jim Marks with the Carroll County Board of Education, addressed the Planning and Zoning Commission in response to questions given by the Commission regarding the proposed project.

**Motion:** Commissioner Beaver moved the City of Westminster Planning and Zoning Commission to approve the conditional approval of Site Development Plan S-24-0032, Westminster Elementary School addition, with the following conditions of approval: Address all outstanding City and County comments prior to submission of signature set mylars. Commissioner Voight seconded the motion. There was no discussion. The motion passed, 5-0.

### **III. Old Business**

There was no old business to discuss.

### **Carroll County Liaison Report**

Carlisle Fillat with Carroll County Planning Department was unable to attend the meeting. Ms. Fillat submitted information on upcoming projects in the Council for the Commission's information. There was no discussion.

**IV. Planning Commission Comments**

The February 2026 Planning and Zoning Commission will be held on Thursday, February 19, 2026, at 6:00 p.m.

**V. Adjournment**

**Motion:** Chair Beyard requested a motion to adjourn the meeting. Commissioner Voight moved to adjourn the City of Westminster Planning and Zoning Meeting of January 22, 2026. Commissioner Beaver seconded the motion. The motion passed 5-0.

The meeting adjourned at 6:23 p.m.

---

Mr. Tom Beyard, Chair  
City of Westminster Planning and Zoning Commission

Official Recordings of the City of Westminster Planning and Zoning Commission are available for viewing in their entirety on the City's YouTube channel.

Adopted by the City of Westminster Planning and Zoning Commission on \_\_\_\_\_.



To: Westminster Planning and Zoning Commission

From: Andrea Gerhard, Comprehensive Planner

cc: Mark A. Depo, Director of Community Planning and Development

Meeting Date: February 19, 2025

Subject: **2025 City of Westminster Planning Annual Reporting Information**

### **BACKGROUND**

Pursuant to the Annotated Code of Maryland, Land Use Article, Section 1-207, “*On or before July 1 of each year, a planning commission [City of Westminster Planning and Zoning Commission] shall prepare, adopt, and file an annual report for the previous calendar year with the legislative body.*” [Attachment 1] The Department of Community Planning and Development (DCPD) has compiled the State-required 2025 Annual Reporting information into the draft 2025 City of Westminster Planning Annual Reporting Information. The draft 2025 City of Westminster Planning Annual Reporting Information follows a three-step review process:

- Step 1: The draft 2025 City of Westminster Planning Annual Reporting Information is introduced to the City of Westminster Planning and Zoning Commission (Commission) and provided to the Carroll County Department of Planning. *(February 19, 2026 Planning and Zoning Commission Meeting)*
- Step 2: Carroll County Department of Planning coordinates, collects, combines, and formats the annual reporting information from the County, the City of Westminster, and the other seven Carroll County municipalities into the draft Carroll County Planning Annual Report (Annual Report) and presents the draft Annual Report to the Commission for review, comments, and corrections.
- Step 3: Carroll County Department of Planning presents the corrected and updated Annual Report to the Commission for review and approval.

If the Commission approves the Annual Report, the Commission Chair will subsequently sign a letter acknowledging Commission approval, which will be included in the final Annual Report along with the other seven municipal approval letters. Carroll County Department of Planning will then forward the Annual Report to the Maryland Department of Planning.

### **ATTACHMENTS**

1. 2025 City of Westminster Planning Annual Reporting Information
2. City of Westminster Planning and Zoning Commission Report Letter

# 2025 City of Westminster, Maryland Planning Annual Report Material



The following information is requested by the Carroll County Department of Planning for the yearly report related to development measures and indicators, as required in the Land Use Article Section 1-208 of the Annotated Code of Maryland

Prepared by the Westminster Department of Community Planning and Development

# Annual Report 2025

- City of Westminster -

## Comprehensive Plans & Plan Elements (this would also include Tiers & Planning Areas)

1. Were any new comprehensive plan or plan elements adopted?     Yes     No
  2. Were there any amendments to the comprehensive plan or plan elements?     Yes     No
- If yes to either #1 or #2 above, please list:

Resolution #	Date adopted	Summary of main concepts

## Subdivision & Site Plan Approvals

1. Did any new Residential Subdivisions receive final approval from Planning Commission in **2025**?     Yes     No
- If yes, please list:

County File #	Name	Total Site Plan Area Approved (Gross Acres)	# of New Lots	# of New Units/ Dwellings	Lot Buildable Land Area (Square feet) <sup>1</sup>	Zoning	Map #	Block/ Grid #	Parcel #
N/A	McDaniel Overlook	1.23	2	2	53610.30	R-10,000	38	18	63

<sup>1</sup> **LOT BUILDABLE LAND AREA** is that portion of a development site where construction can legally and reasonably occur – so public streets and rights-of way, wetlands and watercourses, and other constraints would not be included.

**Buildable Land Area = (Parcel Width x Parcel Depth) – Square feet of undevelopable land (if applicable)<sup>1</sup>**

2. Did any new non-residential site plans receive final approval from Planning Commission in **2025**?

Yes  No

If yes, please list:

County File #	Name	Type of Non-residential Development Approved	Total Site Plan Area Approved (Gross Acres)	Gross Floor Area of Building <sup>2</sup> (Square Feet)	Zoning	Map #	Block/ Grid #	Parcel #
S-23-0036	The Shepherd Staff	Community Center/Meeting Hall	.28	9,313	R-7,500	104	0003	1311-B
S-18-0037	My K-9 Buddy	Dog Training and Event Facility	5.42	40,000	I-R Restricted Industrial	114	8	6784

<sup>2</sup> **GROSS FLOOR AREA** is the sum of the floor area (typically measured between the exterior walls) of each story. **Gross Floor Area = Floor Area of 1st Story + Floor Area of 2nd Story... for all floors above the ground**

## Zoning Map & Text Amendments

1. Were there any annexations?  Yes  No

If yes, please list:

Date adopted	Resolution number	Name	Current (new) zoning
1/27/2025	24-11	Optimum Properties LLC	R-10,000
1/27/2025	24-13	Ellen Potepan	R-10,000
7/28/2025	25-06	1012 Baltimore Boulevard	B-Business

2. If yes to municipal annexations, have copies of each adopted resolution been submitted to:  Yes  No  
 Georgeanne Carter, Legislative Counsel Municipal Resolution Reposition Department of Legislative Services, 90 State Circle, Annapolis MD, 21401-1991?

3. Were there any amendments to the zoning map?  Yes  No  
 If yes, please list and provide map:

Date adopted	Resolution number	Description of change	Parcel #
2/24/2025	Ordinance 2025-02	Amending the Zoning Map for certain real property located at 222 E. Green Street, Westminster, MD 21157 to superimpose the Compatible Neighborhood Overlay Zone (CN Zone) over the existing R-7,500 Residential Zone (R-7,500 Zone) to develop Multiple-Family Dwelling Units.	1537
2/24/2025	Ordinance 2025-03	Adopting a sectional map amendment to amend the boundaries of the Cannabis Overlay District, for the purpose of establishing the appropriate locations for the designation of cannabis overlay floating zones permitting the operation of cannabis businesses in the City.	various
4/24/2025	Ordinance 2025-04	Adopting Local Map Amendment LMA 25-02 to designate certain real property identified as tax account number 07-153155, Tax Map 0113, Grid 0009 Parcel 6805 located in in the I-R Restricted Industrial Zone as a floating Cannabis Overlay Zone for the establishment of a cannabis processor.	6805

4. Were there any text amendments?  Yes  No

Date adopted	Resolution number	Description of change
2/25/2025	Ordinance 2024-09	Amending Chapter 164, "Zoning and Subdivision of Land", of the City Code, to amend Article I, "General Provisions", to add definitions of "Specialty Shop", "Tobacconist", and "Vape Shop"; to amend Article VIIA, "Mixed Use Infill Zone"; Article VIII, "B Business Zone"; Article VIIIB, "D-B Downtown Business Zone"; Article IX, "C-B Central Business Zone"; and Article XII, "P-I Planned Industrial Zone" to add Tobacconists and Vape Shops as permitted uses; to amend Article XIA, "N-C Neighborhood Commercial Zone" to add Vape Shops as a permitted use; to amend Article XX, "Special provisions", to impose certain restrictions on the location of Vape Shops; and to renumber without substantive change the lists of permitted uses in certain of those zones.
10/13/2025	Ordinance 2025-01	Amending Chapter 164, "Zoning and Subdivision of Land", of the Code of the City of Westminster, § 164-3 "Definitions and Word Usage" to add the definitions of "Automobile Detailing Shop," "Automobile Repair and Service Shop, Major," "Automobile Repair and Service Shop, Minor," and "Automobile Sales," and to replace the term "Service Station" with "Automobile Service Station"; to amend §164-121 "On-Premises Business Signs" and Article XX "Special Provisions," § 164-149 "Automobile Service Stations," as well as the permitted uses and/or special exception uses in the MUI Zone, B Zone, D-B Zone, I-R Zone, I-G Zone, N-C Zone, P-I Zone and PRSC Zone, to reflect the newly defined uses, and to renumber without substantive change to the lists of permitted and special exception uses in certain of those zones.
12/8/2025	Ordinance 2025-09	Amending Chapter 164, "Zoning and Subdivision of Land", of the Code of the City of Westminster, Article XII, "P-I Planned Industrial Zone", § 164-66, "Uses permitted", to add "Hotels" as a permitted use and Article XII, "P-I Planned Industrial Zone", § 164-75(D) "Procedures" and Article XXIII, "Amendments", § 164-188 "Planned development" to authorize the Planning and Zoning Commission, rather than the Mayor and Common Council, to approve amendments to an approved development plan designating areas of the planned industrial zone for retail and commercial uses, and to increase the allowable gross acreage of such uses from 15% to 30%.

**Facilities**

1. Were there new roads or substantial changes in roads or other transportation facilities?  Yes  No  
 If yes, please list:

Road Name	From	To	Type of Change

2. Was there development that was modified due to APFO restrictions?  Yes  No  
 If yes, please list:

- Location of the restriction
- Infrastructure affected by the restriction
- The proposed resolution of the restriction (if available)
- Estimated date for resolving the restriction (if available)
- Date a restriction was lifted (if applicable)
- Terms of the resolution that removed the restriction

3. Were there new parks or park changes?  Yes  No  
 If yes, please list:

Park Name	Location	Description of changes
Wakefield Valley Park	100 Fenby Farm Road Westminster, MD 21158	Wakefield Valley Park Event Center completed.

## Other Changes in Development Patterns

1. Where there PFA amendments?  Yes  No

If yes, please list:

Date of amendment	Summary of amendment	Provide map
		<input type="checkbox"/> Attached
		<input type="checkbox"/> Attached

## References

Metropolitan Council. (n.d.). *Calculating Floor Area Ratio Handbook - Metropolitan Council*. Retrieved from Metropolitan Council Facts: <https://metrocouncil.org/Handbook/Files/Resources/Fact-Sheet/LAND-USE/How-to-Calculate-Floor-Area-Rat>



## CITY OF WESTMINSTER, MARYLAND

[www.westminstermd.gov](http://www.westminstermd.gov)

---

### Planning and Zoning Commission

45 West Main Street  
Westminster, Maryland 21157  
[planning@westminstermd.gov](mailto:planning@westminstermd.gov)

February 19, 2026

Office of the Secretary  
Maryland Department of Planning  
301 W. Preston Street, Suite 1101  
Baltimore, Maryland 21201-2305  
Attn: David Dahlstrom, AICP

### **RE: Carroll County 2025 Annual Report**

Dear Mr. Dahlstrom:

Pursuant to the requirements of the Land Use Article § 1-207 of the Annotated Code of Maryland, the City of Westminster Planning Commission has approved the requested 2025 Annual Report data for submittal as presented on February 19, 2026 to be included in the Carroll County 2025 Annual Report. Data related to development measures and indicators, as required in the Land Use Article § 1-208, are also to be included.

We are participating in the development of the report by providing data to be incorporated in the report that accurately reflects planning and development activities within our jurisdiction. Upon the completion of the report, the jointly developed report should incorporate the required summary of activities and highlights for the Carroll County Planning & Zoning Commission, as well as for Planning Commissions of the County's eight participating municipalities into one unified document.

If you have any questions concerning the report or its contents, please contact the Carroll County Department of Planning at (410) 386-5145.

Sincerely,

Thomas Beyard  
Planning and Zoning Commission Chair



## PLANNING AND ZONING COMMISSION

February 19, 2025

**TITLE:** Final Resubdivision Plat, Chick-fil-A

**APPLICANT REQUEST:**

To resubdivide two parcels (SDAT# 07-029233 and 07-029241) located in the southeast quadrant of the Baltimore Blvd. (MD Route 140)/Old Baltimore Blvd. intersection to create new Lot 1 and Lot 2, to develop new Lot 1 with a Chick-fil-A restaurant, pursuant to conditionally approved Site Development Plan S-23-0001.

**PROJECT INFORMATION:**

**ZONE:** B Business Zone  
**EXISTING USE:** Vacant  
**PROPOSED USE:** Lot 1, Restaurant (Z.O, Section 164-41(45)) & Lot 2, Vacant  
**SITE AREA:** 345,807 square feet or 7.84 acres

**APPLICANT/REPRESENTATIVES:**

**APPLICANT:** The Morgan Companies, c/o Scott Friedman  
4521 Sharon Road, Suite 275, Charlotte NC 28211  
**OWNER:** Baltimore Blvd Realty LLC, c/o Scott Friedman  
4521 Sharon Road, Suite 275, Charlotte NC 28211  
**ATTORNEY:** Kelly S. Miller, Shaffer and Shaffer LLP  
73 E Main Street, Westminster, MD 21157  
**ENGINEER:** Daniel Haney, Bohler  
901 Dulaney Valley Road, Suite 801, Towson, MD 21204

**STAFF:** Andrea Gerhard, Senior Planner  
Mark A. Depo, Director of Community Planning and Development

**RECOMMENDATION:** Approval

**ATTACHMENTS:**

1. Final Resubdivision Plat, Chick-fil-A
2. Market Street Right-of Way Carroll County Dedication Plat



# STAFF REPORT

Article XXIV, Subdivision Regulations, of the City of Westminster Zoning Ordinance (“Zoning Ordinance”) requires the Planning and Zoning Commission (“Commission”) and Planning Director to review and act on resubdivisions, and amendments thereto.

## VICINITY MAP/ LOCATION:

The subject property referred to as “Annexation 67 Schulte Property” is located in the southeast quadrant of the Baltimore Blvd. (MD Route 140) and Old Baltimore Blvd. intersection and further identified as tax account number SDAT #07-029233 and #07-029241 (the “Property”). The Property is 7.84 acres in size and zoned B Business Zone (Zoning Ordinance Article VIII) and subject to the Zoning Ordinance.



 = Property     = General Location of Chick-fil-A

## RESUBDIVISION INFORMATION:

The Morgan Companies (the “Applicant”), represented by Scott Friedman filed Site Development Plan S-23-0001, Chick-fil-A. S-23-0001 proposes to construct a 5,493 square feet Restaurant building and accompanying parking area and landscaping.

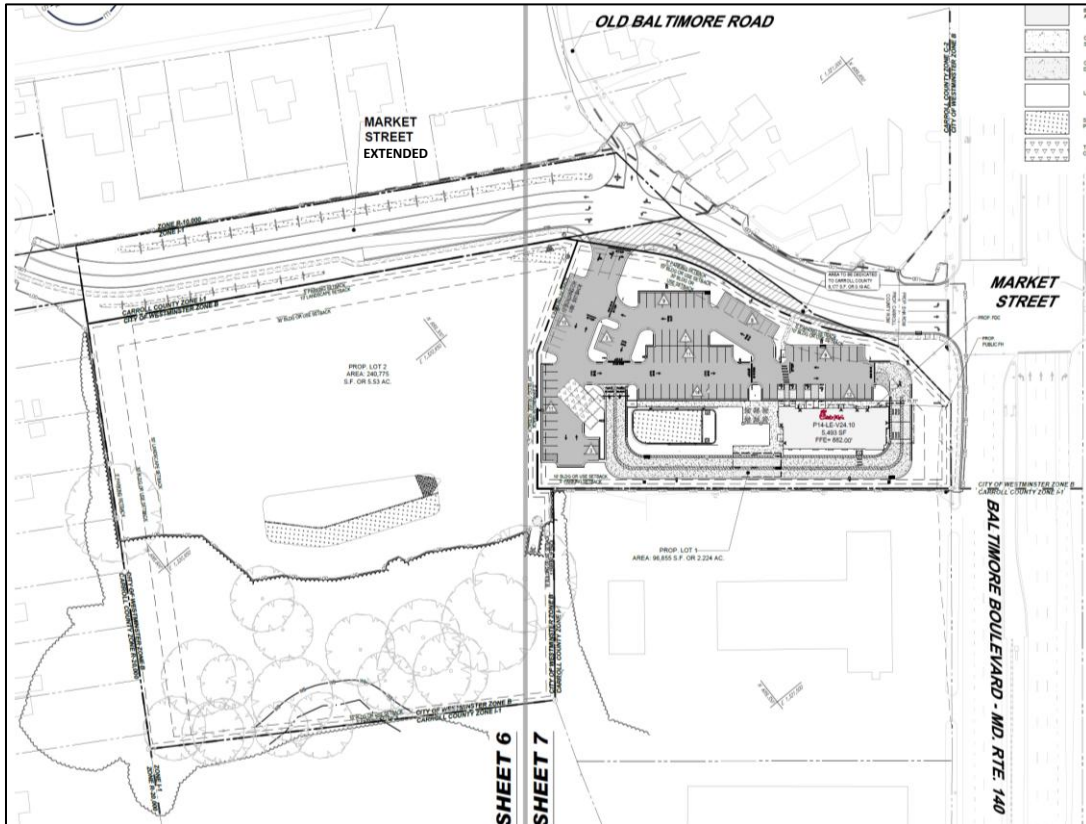

On August 21, 2025, the Commission conditionally approved Site Development Plan S-23-0001, Chick-fil-A, with the following conditions of approval:

1. Address all outstanding City and County comments prior to submission of signature set mylars.
2. Prior to final signature set approval of S-23-0001, Chick-fil-A, the resubdivision of the existing properties through a boundary line adjustment must be approved by the City and recorded among the Carroll County Land Records.
3. Construction of Market Street extended, beyond the stage of excavation or grading, must start prior to City of Westminster approval of building permits for S-23-0001 and construction of Market Street extended must be completed and accepted by the County Commissioners of Carroll County prior to City of Westminster approval of use and occupancy for S-23-0001.

The Applicant is proposing to resubdivide the two existing parcels (SDAT# 07-029233 and 07-029241) located in the southeast quadrant of the Baltimore Blvd. (MD Route 140)/Old Baltimore

Bldv. intersection to create new Lot 1 (2.224 acres) and new Lot 2 (5.458). [Attachment 1] Lot 1 will contain the Chick-fil-a development, pursuant to conditionally approved Site Development Plan S-23-0001, and Lot 2 will provide for additional future commercial/retail development and contain stormwater management for the development of both lots. The plat is also dedicating 0.256 acres to Carroll County for the development of Market Street extended.

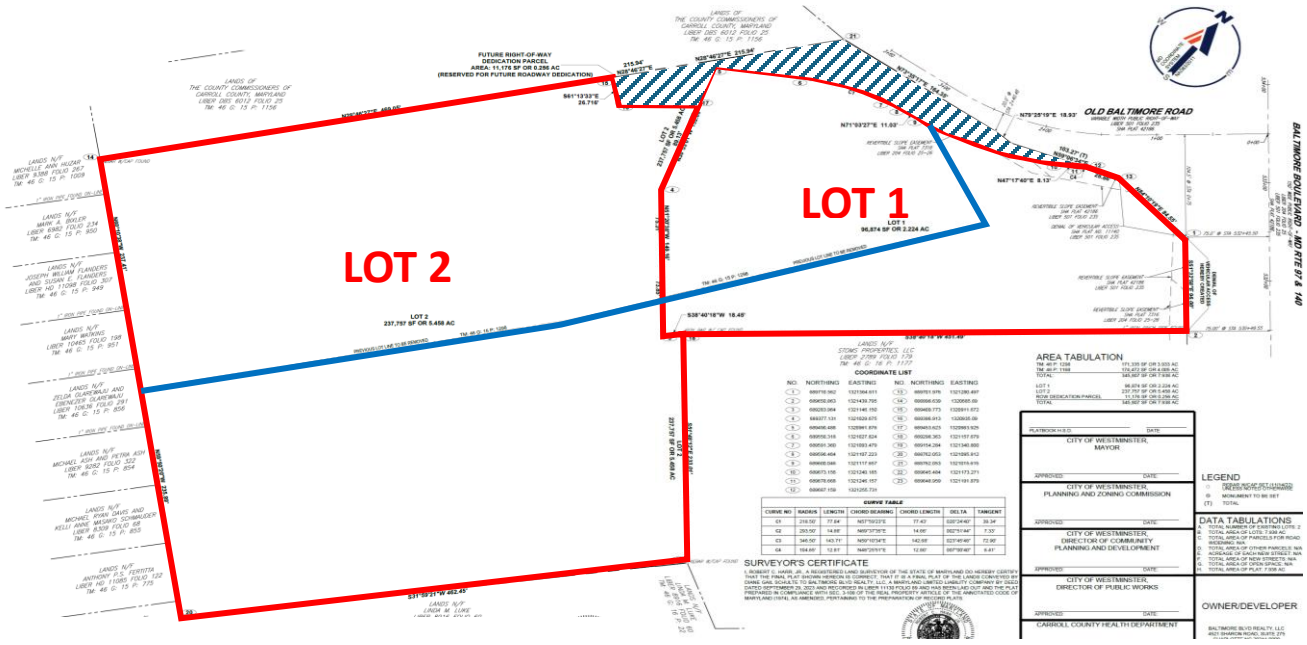

- = New Lots
- = Removed Lot Line
- = Market Street R-O-W Dedication

**Market Street Extended**

Market Street Extended is a Carroll County roadway and Carroll County is responsible for the design, construction, or maintenance of the roadway. Market Street Extended’s intersection with Route 140 must be approved by SHA. As such, the City of Westminster has no control on the design and construction of Market Street Extended and can only make suggestions.

On June 26, 2025, Carroll County Public Works Director confirmed that Carroll County approved the final design of Market Street Extended and confirmed that all SHA comments related to the State’s right-of-way have been addressed. The Applicant is coordinating with Carroll County on the dedication are necessary to develop Market Street Extended. [Attachment 2]

**PROCESS:**

Pursuant to Zoning Ordinance Section 164-3, Definitions and word usage, SUBDIVISION is defined as “The division or redivision of any lot, tract or parcel of land into two or more lots, plats, parcels, sites or other divisions of land, whether for immediate or future sale, lease or building development. If a new street is involved, subdivision shall mean any division of a tract or parcel of land. The sale or exchange of parcels of land between owners of adjoining properties for the purpose of small adjustments in boundaries shall not be considered a subdivision, provided that additional lots are not thereby created and that the original lots are not reduced below the minimum sizes required by this chapter.”

Pursuant to Zoning Ordinance Section 164-3, Definitions and word usage, MINOR SUBDIVISION is defined as “A subdivision of fewer than three lots.”

Pursuant to Zoning Ordinance Section 164-201, Resubdivision or minor subdivision, “The procedure for the filing of a final plat for the resubdivision of a lot or parcel or for a minor subdivision shall be as indicated in this article for an original subdivision, except that the submission of a preliminary plan shall be at the option of the applicant.” The Commission shall approve, approve subject to conditions, or not approve the resubdivision, and amendments thereto.

**RECOMMENDATION:**

DCPD recommends that the Planning and Zoning Commission consider Conditional Approval of the proposed Final Resubdivision Plat, Chick-fil-A, with the following conditions of approval:

- 1. Address all outstanding City and County comments prior to submission of signature set mylars.

**DRAFT MOTIONS FOR RESUBDIVISION FINAL PLAT, CHICK-FIL-A:**

- 1. I move that the Planning and Zoning Commission conditionally approve Final Resubdivision Plat, Chick-fil-A, pursuant to City of Westminster Zoning Ordinance Article XXIV, and based on the February 19, 2025, Staff Report and conditions of approval.

OR

- 2. I move that the Planning and Zoning Commission deny Final Resubdivision Plat, Chick-fil-A.

OR

- 3. I move an alternate motion.

LANDS OF  
THE COUNTY COMMISSIONERS OF  
CARROLL COUNTY, MARYLAND  
LIBER DBS 6012 FOLIO 25  
TM: 46 G: 15 P: 1156

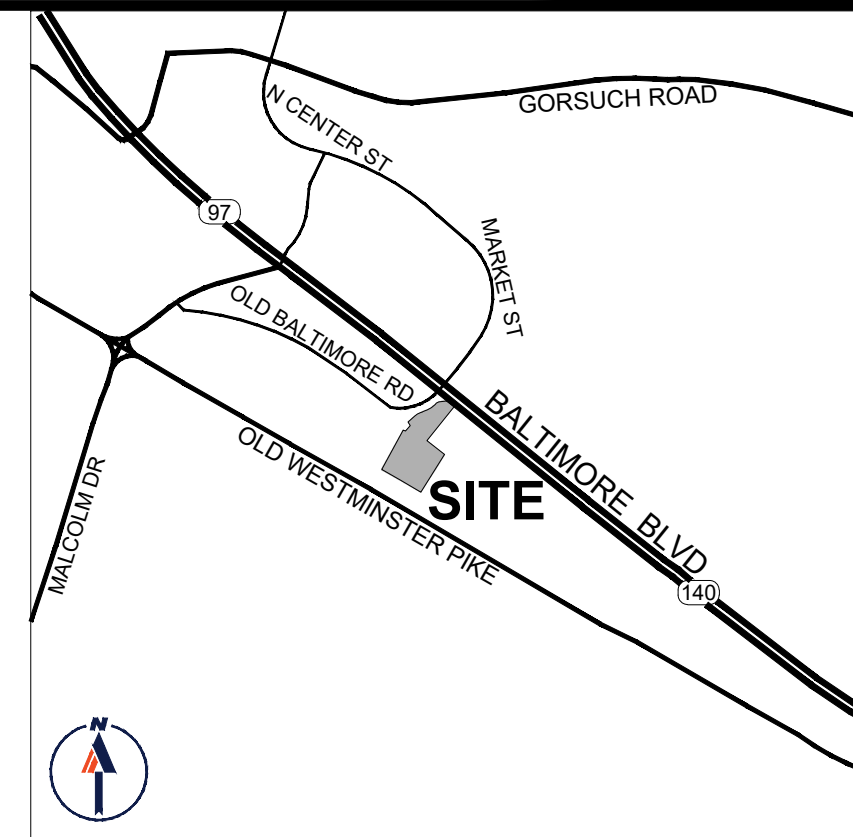
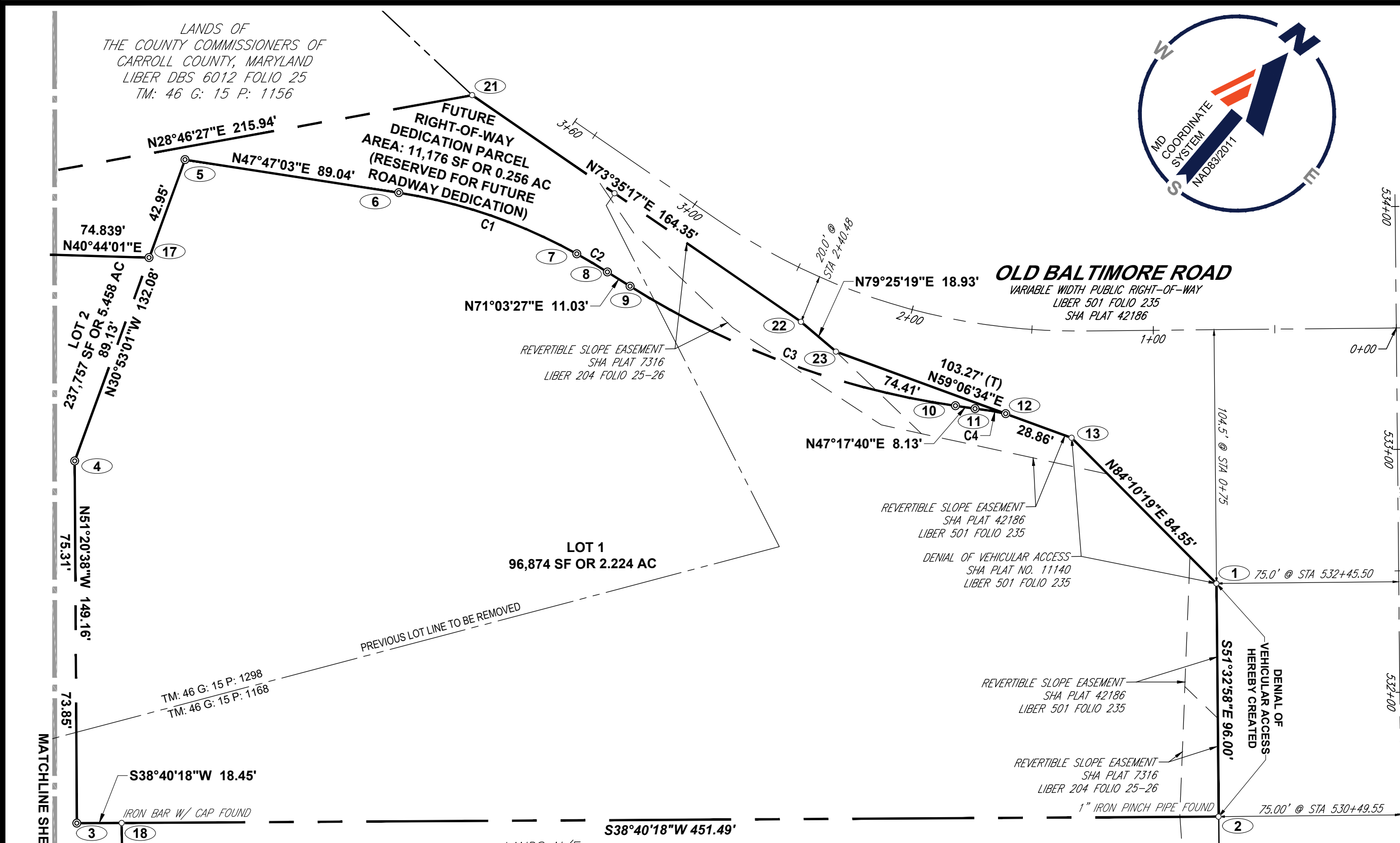

VICINITY MAP  
SCALE: 1" = 2,000'

**NOTES**

- THE PROPERTIES SHOWN HEREON ARE OWNED BY BALTIMORE BLVD REALTY, LLC, BY DEED DATED SEPTEMBER 29, 2023 RECORDED IN LIBER 11130 FOLIO 89, AMONG THE LAND RECORDS OF CARROLL COUNTY, MARYLAND.
- NO GRADING, FILLING OR CONSTRUCTION SHALL BE PERMITTED WHICH OBSTRUCTS OR INHIBITS THE SURFACE FLOW OF WATER WITHIN DRAINAGE AND UTILITY EASEMENTS AS SHOWN HEREON.
- NOTHING SHOWN OR STATED ON THIS PLAT SHALL CREATE A COVENANT OR RESTRICTION OF TITLE.
- THIS PLAT WAS PREPARED WITH REFERENCE TO COMMITMENT FOR TITLE INSURANCE PREPARED BY FIRST AMERICAN TITLE INSURANCE COMPANY COMMITMENT NO. 5129303-F-MD-MP-GRS, WITH A COMMITMENT DATE OF AUGUST 28, 2023.
- ALL DRIVEWAYS SHALL BE PAVED ACCORDING TO CARROLL COUNTY ZONING REGULATIONS AND SPECIFICATIONS.
- NO BUILDING PERMIT OR ZONING CERTIFICATE SHALL BE ISSUED FOR ANY LOT SHOWN HEREON UNTIL SUCH TIME AS THE SITE DEVELOPMENT PLAN HAS BEEN APPROVED BY THE TOWN OF MOUNT AIRY PLANNING COMMISSION.
- ANY MODIFICATION OR PLAT REASSEMBLY SHALL BE SUBJECT TO APPROVAL BY THE CARROLL COUNTY PLANNING AND ZONING COMMISSION.
- IF AND WHEN PUBLIC/COMMUNITY WATER AND/OR SEWERAGE FACILITIES BECOME AVAILABLE TO THE LOTS IN THIS SUBDIVISION, THE LOT OWNER(S) SHALL BE REQUIRED TO CONNECT TO THE SYSTEM IN ACCORDANCE WITH APPLICABLE LAW.

**OWNER'S CERTIFICATE**

WE, OWNERS OF THE PROPERTY SHOWN HEREON, AND DESCRIBED IN THE SURVEYOR'S CERTIFICATE, HEREBY ADOPT THIS PLAT OF CONSOLIDATION, ESTABLISH THE BUILDING LINES AS SHOWN, AND CERTIFY THAT THE REQUIREMENTS OF SECTION 3-108 OF THE REAL PROPERTY ARTICLE OF THE ANNOTATED CODE OF MARYLAND AS AMENDED AS PERTAINING TO THE PREPARATION OF THIS PLAT AND THE SETTING OF MARKERS HAVE BEEN COMPLIED WITH.

OWNER: BALTIMORE BLVD REALTY, LLC  
BY: \_\_\_\_\_  
NAME \_\_\_\_\_ DATE \_\_\_\_\_

**PURPOSE NOTE:**  
THE PURPOSE OF THIS PLAT IS TO COMBINE THE LANDS OF BALTIMORE BLVD REALTY, LLC TO CREATE LOTS 1, 2, AND RIGHT-OF-WAY DEDICATION PARCEL.

No.	DESCRIPTION OF REVISION	DATE
1.	REVISED PER CLIENT COMMENTS	05/02/2025
2.	REVISED PER COUNTY COMMENTS	01/22/2026

**AREA TABULATION**

TM: 46 P: 1298	171,335 SF OR 3.933 AC
TM: 46 P: 1168	174,472 SF OR 4.005 AC
<b>TOTAL:</b>	<b>345,807 SF OR 7.938 AC</b>
LOT 1	96,874 SF OR 2.224 AC
LOT 2	237,757 SF OR 5.458 AC
ROW DEDICATION PARCEL	11,176 SF OR 0.256 AC
<b>TOTAL</b>	<b>345,807 SF OR 7.938 AC</b>

**COORDINATE LIST**

NO.	NORTHING	EASTING	NO.	NORTHING	EASTING
1	689710.562	1321364.611	13	689701.976	1321280.497
2	689650.863	1321439.795	14	688998.639	1320685.89
3	689283.964	1321146.150	15	689409.773	1320911.672
4	689377.131	1321029.675	16	689396.913	1320935.09
5	689490.488	1320961.876	17	689453.623	1320983.925
6	689550.318	1321027.824	18	689298.363	1321157.679
7	689591.360	1321093.479	19	689154.284	1321340.800
8	689596.464	1321107.223	20	688762.053	1321095.812
9	689600.046	1321117.657	21	688762.053	1321015.615
10	689673.156	1321240.185	22	689645.484	1321173.271
11	689678.668	1321246.157	23	689648.959	1321191.879
12	689687.159	1321255.731			

**CURVE TABLE**

CURVE NO	RADIUS	LENGTH	CHORD BEARING	CHORD LENGTH	DELTA	TANGENT
C1	218.50'	77.84'	N57°59'23"E	77.43'	020°24'40"	39.34'
C2	293.50'	14.66'	N69°37'35"E	14.66'	002°51'44"	7.33'
C3	346.50'	143.71'	N59°10'34"E	142.68'	023°45'48"	72.90'
C4	104.65'	12.81'	N48°25'51"E	12.80'	007°00'40"	6.41'

**SURVEYOR'S CERTIFICATE**

I, ROBERT C. HARR, JR., A REGISTERED LAND SURVEYOR OF THE STATE OF MARYLAND DO HEREBY CERTIFY THAT THE FINAL PLAT SHOWN HEREON IS CORRECT; THAT IT IS A FINAL PLAT OF THE LANDS CONVEYED BY DIANE GAIL SCHULTE TO BALTIMORE BLVD REALTY, LLC, A MARYLAND LIMITED LIABILITY COMPANY BY DEED DATED SEPTEMBER 29, 2023 AND RECORDED IN LIBER 11130 FOLIO 89 AND HAS BEEN LAID OUT AND THE PLAT PREPARED IN COMPLIANCE WITH SEC. 3-108 OF THE REAL PROPERTY ARTICLE OF THE ANNOTATED CODE OF MARYLAND (1974), AS AMENDED, PERTAINING TO THE PREPARATION OF RECORD PLATS.



ROBERT C. HARR, JR., PROFESSIONAL LAND SURVEYOR  
MARYLAND REGISTRATION No. 21587  
EXP. JANUARY 16, 2027  
DATE \_\_\_\_\_

PLATBOOK H.S.D. _____	DATE _____
<b>CITY OF WESTMINSTER, MAYOR</b>	
APPROVED: _____	DATE: _____
<b>CITY OF WESTMINSTER, PLANNING AND ZONING COMMISSION</b>	
APPROVED: _____	DATE: _____
<b>CITY OF WESTMINSTER, DIRECTOR OF COMMUNITY PLANNING AND DEVELOPMENT</b>	
APPROVED: _____	DATE: _____
<b>CITY OF WESTMINSTER, DIRECTOR OF PUBLIC WORKS</b>	
APPROVED: _____	DATE: _____
<b>CARROLL COUNTY HEALTH DEPARTMENT</b>	
APPROVED: _____	DATE: _____

**LEGEND**

- REBAR W/CAP SET (11/14/22) UNLESS NOTED OTHERWISE
- ⊙ MONUMENT TO BE SET
- (T) TOTAL

**DATA TABULATIONS**

- A. TOTAL NUMBER OF EXISTING LOTS: 2
- B. TOTAL AREA OF LOTS: 7.938 AC
- C. TOTAL AREA OF PARCELS FOR ROAD WIDENING: N/A
- D. TOTAL AREA OF OTHER PARCELS: N/A
- E. ACREAGE OF EACH NEW STREET: N/A
- F. TOTAL AREA OF NEW STREETS: N/A
- G. TOTAL AREA OF OPEN SPACE: N/A
- H. TOTAL AREA OF PLAT: 7.938 AC

**OWNER/DEVELOPER**

BALTIMORE BLVD REALTY, LLC  
4521 SHARON ROAD, SUITE 275  
CHARLOTTE NC 28211-0000



**FINAL PLAT**

THE LANDS OF  
**BALTIMORE BLVD REALTY, LLC**  
LIBER HD 11130 FOLIO 89  
TM: 46 G: 15 P: 1168 & 1298  
7TH ELECTION DISTRICT  
CARROLL COUNTY, MARYLAND  
CARROLL COUNTY FILE NO AP- \_\_\_\_\_

DRAWN BY: ID	SCALE: 1" = 40'	PROJECT NO: MDA220021.01
CHECKED BY: EB	DATE: MARCH 17, 2025	1 OF 2
APPROVED: JB		

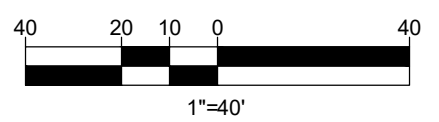



FUTURE RIGHT-OF-WAY  
DEDICATION PARCEL  
AREA: 11,176 SF OR 0.256 AC  
(RESERVED FOR FUTURE ROADWAY DEDICATION)

215.94'  
N28°46'27"E  
74.839'  
N40°44'01"E  
S61°13'33"E  
26.716'

LANDS OF  
THE COUNTY COMMISSIONERS OF  
CARROLL COUNTY, MARYLAND  
LIBER DBS 6012 FOLIO 25  
TM: 46 G: 15 P: 1156

LANDS N/F  
MICHELLE ANN HUZAR  
LIBER 9388 FOLIO 267  
TM: 46 G: 15 P: 1009

LANDS N/F  
MARK A. BIXLER  
LIBER 6982 FOLIO 234  
TM: 46 G: 15 P: 950

LANDS N/F  
JOSEPH WILLIAM FLANDERS  
AND SUSAN E. FLANDERS  
LIBER HD 11098 FOLIO 307  
TM: 46 G: 15 P: 949

LANDS N/F  
MARY WATKINS  
LIBER 10465 FOLIO 198  
TM: 46 G: 15 P: 951

LANDS N/F  
ZELDA OLAREWAJU AND  
EBENEZER OLAREWAJU  
LIBER 10636 FOLIO 291  
TM: 46 G: 15 P: 856

LANDS N/F  
MICHAEL ASH AND PETRA ASH  
LIBER 9282 FOLIO 322  
TM: 46 G: 15 P: 854

LANDS N/F  
MICHAEL RYAN DAVIS AND  
KELLI ANNE MASAKO SCHMAUDER  
LIBER 8309 FOLIO 68  
TM: 46 G: 15 P: 855

LANDS N/F  
ANTHONY P.S. FERTITTA  
LIBER HD 11085 FOLIO 122  
TM: 46 G: 15 P: 775

LANDS N/F  
MARCI L. CARRIGAN AND  
TIMOTHY L. CARRIGAN  
LIBER 7812 FOLIO 231  
TM: 46 G: 16 P: 1352

LOT 2  
237,757 SF OR 5.458 AC

PREVIOUS LOT LINE TO BE REMOVED  
TM: 46 G: 15 P: 1298  
TM: 46 G: 15 P: 1168

LEGEND

- REBAR W/CAP SET (11/14/22)  
UNLESS NOTED OTHERWISE
- ⊙ MONUMENT TO BE SET
- (T) TOTAL

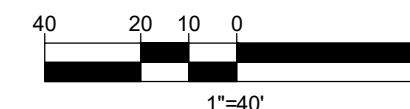

1.	REVISED PER CLIENT COMMENTS	05/02/2025
2.	REVISED PER COUNTY COMMENTS	01/22/2026
No.	DESCRIPTION OF REVISION	DATE

**BOHLER** 12825 WORLDGATE DRIVE, SUITE 700  
HERNDON, VIRGINIA 20170  
703.709.9500  
www.bohlerengineering.com

■ UPSTATE NEW YORK ■ BOSTON, MA ■ NEW YORK METRO ■ WARREN, NJ ■ PHILADELPHIA/SOUTHERN NJ ■ LEHIGH VALLEY, PA ■ SOUTHEASTERN PA  
■ BALTIMORE, MD ■ SOUTHERN MARYLAND ■ NORTHERN VIRGINIA ■ WASHINGTON, DC ■ CENTRAL VIRGINIA ■ CHARLOTTE, NC ■ RALEIGH, NC

**FINAL PLAT**  
THE LANDS OF  
**BALTIMORE BLVD REALTY, LLC**  
LIBER HD 11130 FOLIO 89  
TM: 46 G: 15 P: 1168 & 1298  
7TH ELECTION DISTRICT  
CARROLL COUNTY, MARYLAND

CARROLL COUNTY FILE NO AP- - -

DRAWN BY: ID	SCALE: 1" = 40'	PROJECT NO: MDA220021.01
CHECKED BY: EB	DATE: MARCH 17, 2025	2 OF 2
APPROVED: JB		



ROBERT C. HARR, JR., PROFESSIONAL LAND SURVEYOR  
MARYLAND REGISTRATION No. 21587  
EXP. JANUARY 16, 2027  
DATE

MATCHLINE SHEET 1

**NOTES**

- THE PROPERTIES SHOWN HEREON ARE OWNED BY THE COUNTY COMMISSIONERS OF CARROLL COUNTY BY DEEDS DATED JUNE 06, 2007 AND RECORDED IN LIBER DBS 5266 FOLIO 105, MARCH 10, 2023 AND RECORDED IN LIBER HD 10997 FOLIO 204 AUGUST 30, 2007 AND RECORDED IN LIBER DBS 5342 FOLIO 186, OCTOBER 13, 2009 AND RECORDED IN LIBER DBS 6012 FOLIO 25, AND BY BALTIMORE BLVD REALTY, LLC, BY DEED DATED SEPTEMBER 29, 2023 RECORDED IN LIBER HD 11130 FOLIO 89, ALL RECORDED AMONG THE LAND RECORDS OF CARROLL COUNTY, MARYLAND.
- NO GRADING, FILLING OR CONSTRUCTION SHALL BE PERMITTED WHICH OBSTRUCTS OR INHIBITS THE SURFACE FLOW OF WATER WITHIN DRAINAGE AND UTILITY EASEMENTS AS SHOWN HEREON.
- ANY MODIFICATION OR PLAT REASSEMBLY SHALL BE SUBJECT TO APPROVAL BY THE CARROLL COUNTY PLANNING AND ZONING COMMISSION.
- THIS PLAT WAS PREPARED WITHOUT THE BENEFIT OF A COMMITMENT FOR TITLE INSURANCE.
- NO BUILDING PERMIT OR ZONING CERTIFICATE SHALL BE ISSUED FOR ANY LOT SHOWN HEREON UNTIL SUCH TIME AS A SITE DEVELOPMENT PLAN HAS BEEN APPROVED BY THE CARROLL COUNTY PLANNING AND ZONING COMMISSION.

**COORDINATE LIST**

NO.	NORTHING	EASTING	NO.	NORTHING	EASTING	NO.	NORTHING	EASTING
1	688885.820	1320375.232	10	689666.829	1321126.971	19	689550.319	1321027.824
2	689089.190	1321439.795	11	689753.850	1321217.057	20	689490.488	1320961.876
3	689026.466	1320601.051	12	689701.977	1321280.497	21	689453.623	1320983.925
4	689042.059	1320609.989	13	689687.160	1321255.731	22	689396.914	1320935.090
5	689585.101	1320913.856	14	689678.669	1321246.157	23	689409.774	1320911.672
6	689590.774	1320916.299	15	689673.157	1321240.185	24	688998.639	1320685.890
7	689612.864	1320922.514	16	689600.046	1321117.657	25	689012.287	1320662.081
8	689636.728	1321032.318	17	689596.465	1321107.223	26	688795.395	1320537.752
9	689656.937	1321101.795	18	689591.361	1321093.479			

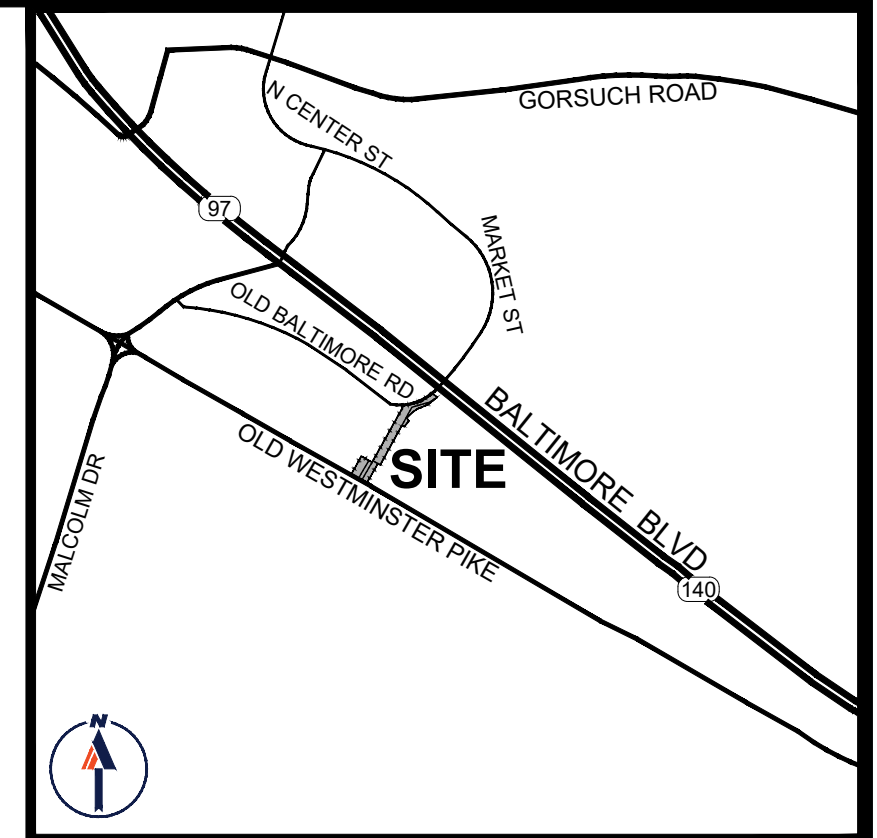

VICINITY MAP  
SCALE: 1" = 2,000'



**OWNER'S CERTIFICATE**

THE OWNER(S), TO THE BEST OF HIS (THEIR) KNOWLEDGE, AND THE SURVEYOR DO HEREBY CERTIFY THAT THE LAND SHOWN HEREON HAS BEEN LAID OUT AND THE PLAT PREPARED IN COMPLIANCE WITH SECTION 3-108 OF THE REAL PROPERTY ARTICLE OF THE ANNOTATED CODE OF MARYLAND, AS AMENDED, PERTAINING TO THE PREPARATION OF RECORD PLATS.

OWNER: BALTIMORE BLVD REALTY, LLC  
BY: \_\_\_\_\_

NAME \_\_\_\_\_ DATE \_\_\_\_\_

OWNER: THE COUNTY COMMISSIONERS OF CARROLL COUNTY, MARYLAND  
BY: \_\_\_\_\_

NAME \_\_\_\_\_ DATE \_\_\_\_\_

**SURVEYOR'S CERTIFICATE**

I, ROBERT C. HARR, JR., A REGISTERED LAND SURVEYOR OF THE STATE OF MARYLAND DO HEREBY CERTIFY THAT THE FINAL PLAT SHOWN HEREON IS CORRECT; THAT IT IS A FINAL PLAT OF THE LANDS CONVEYED BY DORIS M. DOBSON TO THE COUNTY COMMISSIONERS OF CARROLL COUNTY, MARYLAND BY DEED DATED JUNE 06, 2007 AND RECORDED IN LIBER DBS 5266 FOLIO 105 AND DIANE GAIL SCHULTE TO THE COUNTY COMMISSIONERS OF CARROLL COUNTY, MARYLAND BY DEED DATED MARCH 10, 2023 AND RECORDED IN LIBER HD 10997 FOLIO 204, JOHN C. GILBERT AND RENEE N. GILBERT TO THE COUNTY COMMISSIONERS OF CARROLL COUNTY, MARYLAND BY DEED DATED AUGUST 30, 2007 AND RECORDED IN LIBER DBS 5342 FOLIO 186, ROGER LARRY MANN TO THE COUNTY COMMISSIONERS OF CARROLL COUNTY, MARYLAND BY DEED DATED OCTOBER 13, 2009 AND RECORDED IN LIBER DBS 6012 FOLIO 25, AND BY DIANE GAIL SCHULTE TO BALTIMORE BLVD REALTY, LLC, A MARYLAND LIMITED LIABILITY COMPANY BY DEED DATED SEPTEMBER 29, 2023 AND RECORDED IN LIBER HD 11130 FOLIO 89 AND HAS BEEN LAID OUT AND THE PLAT PREPARED IN COMPLIANCE WITH SEC. 3-108 OF THE REAL PROPERTY ARTICLE OF THE ANNOTATED CODE OF MARYLAND (1974), AS AMENDED, PERTAINING TO THE PREPARATION OF RECORD PLATS.



ROBERT C. HARR, JR., PROFESSIONAL LAND SURVEYOR  
MARYLAND REGISTRATION No. 21587  
EXP. JANUARY 16, 2027  
DATE \_\_\_\_\_

CURVE TABLE						
CURVE NO	RADIUS	LENGTH	CHORD BEARING	CHORD LENGTH	DELTA	TANGENT
C1	104.65'	12.81'	S48°25'51"W	12.80'	007°00'40"	6.41'
C2	346.50'	143.71'	S59°10'34"W	142.68'	023°45'48"	72.90'
C3	293.50'	14.66'	S69°37'35"W	14.66'	002°51'44"	7.33'
C4	218.50'	77.84'	S57°59'23"W	77.43'	020°24'40"	39.34'

**LEGEND**

- REBAR W/CAP SET (11/14/22) UNLESS NOTED OTHERWISE
- ⊙ MONUMENT TO BE SET
- (T) TOTAL
- ▨ REVERTIBLE SLOPE EASEMENT SHA PLAT 7316 LIBER 204 FOLIO 25
- ▨ REVERTIBLE SLOPE EASEMENT SHA PLAT 7316 LIBER 204 FOLIO 25-26

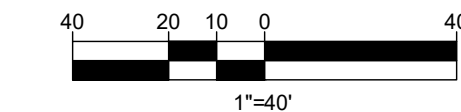

**DATA TABULATIONS**

- A. TOTAL NUMBER OF EXISTING LOTS: 4
- B. TOTAL AREA OF LOTS: 2.345 AC
- C. TOTAL AREA OF OTHER PARCELS: 0.560 AC
- D. ACREAGE OF EACH NEW STREET: 2.905 AC
- E. TOTAL AREA OF NEW STREETS: 2.905 AC
- F. TOTAL AREA OF OPEN SPACE: N/A
- G. TOTAL AREA OF PLAT: 2.905 AC

**OWNER/DEVELOPER**

BALTIMORE BLVD REALTY, LLC  
4521 SHARON ROAD, SUITE 275  
CHARLOTTE, NC 28211-0000  
THE COUNTY COMMISSIONERS OF CARROLL COUNTY, MARYLAND  
P.O. BOX 417  
OXFORD, MD 21654-0417

**AREA TABULATION**

TM: 46 G: 15 P: 1156 (L. 5266 F. 105)	20,584 SF OR 0.473 AC
TM: 46 G: 15 P: 593 (L. 5342 F. 186)	15,000 SF OR 0.344 AC
TM: 46 G: 15 P: 1156 (L. 6012 F. 25)	55,452 SF OR 1.273 AC
RIGHT-OF-WAY DEDICATION PARCEL	11,176 SF OR 0.256 AC
CHESTNUT AVE	9,028 SF OR 0.207 AC
PORTION OF OLD BALTIMORE ROAD	15,301 SF OR 0.352 AC
<b>TOTAL:</b>	<b>126,541 SF OR 2.905 AC</b>

2	REVISED PER COUNTY COMMENTS	06/26/2025
1	REVISED PER CLIENT COMMENTS	05/02/2025

No.	DESCRIPTION OF REVISION	DATE

12825 WORLDGATE DRIVE, SUITE 700  
HERNDON, VIRGINIA 20170  
703.709.9500  
www.bohlerengineering.com

UPSTATE NEW YORK ■ BOSTON, MA ■ NEW YORK METRO ■ WARREN, NJ ■ PHILADELPHIA/SOUTHERN NJ ■ LEHIGH VALLEY, PA ■ SOUTHEASTERN PA ■ BALTIMORE, MD ■ SOUTHERN MARYLAND ■ NORTHERN VIRGINIA ■ WASHINGTON, DC ■ CENTRAL VIRGINIA ■ CHARLOTTE, NC ■ RALEIGH, NC

**FINAL PLAT**  
THE LANDS OF  
**THE COUNTY COMMISSIONERS OF CARROLL COUNTY, MARYLAND**  
LIBER DBS 5266 FOLIO 105  
LIBER 10997 FOLIO 204  
TM: 46 G: 15 P: 1156  
LIBER DBS 5342 FOLIO 186  
TM: 46 G: 15 P: 593  
LIBER DBS 6012 FOLIO 25  
TM: 46 G: 15 P: 1156  
AND  
**BALTIMORE BLVD REALTY, LLC**  
LIBER HD 11130 FOLIO 89  
TM: \_\_\_ G: \_\_\_ P: \_\_\_  
7TH ELECTION DISTRICT  
CARROLL COUNTY, MARYLAND  
CARROLL COUNTY FILE NO. AP-\_\_\_

DRAWN BY: ID	SCALE: 1" = 40'	PROJECT NO: MDA220021.01
CHECKED BY: EB	DATE: APRIL 30, 2025	1 OF 2
APPROVED: JB		

**PURPOSE NOTE:**

THE PURPOSE OF THIS PLAT IS TO VACATE THE PROPERTY LINES OF EXISTING PARCELS OF LAND AND TO DEDICATE MARKET STREET AS PUBLIC RIGHT-OF-WAY.

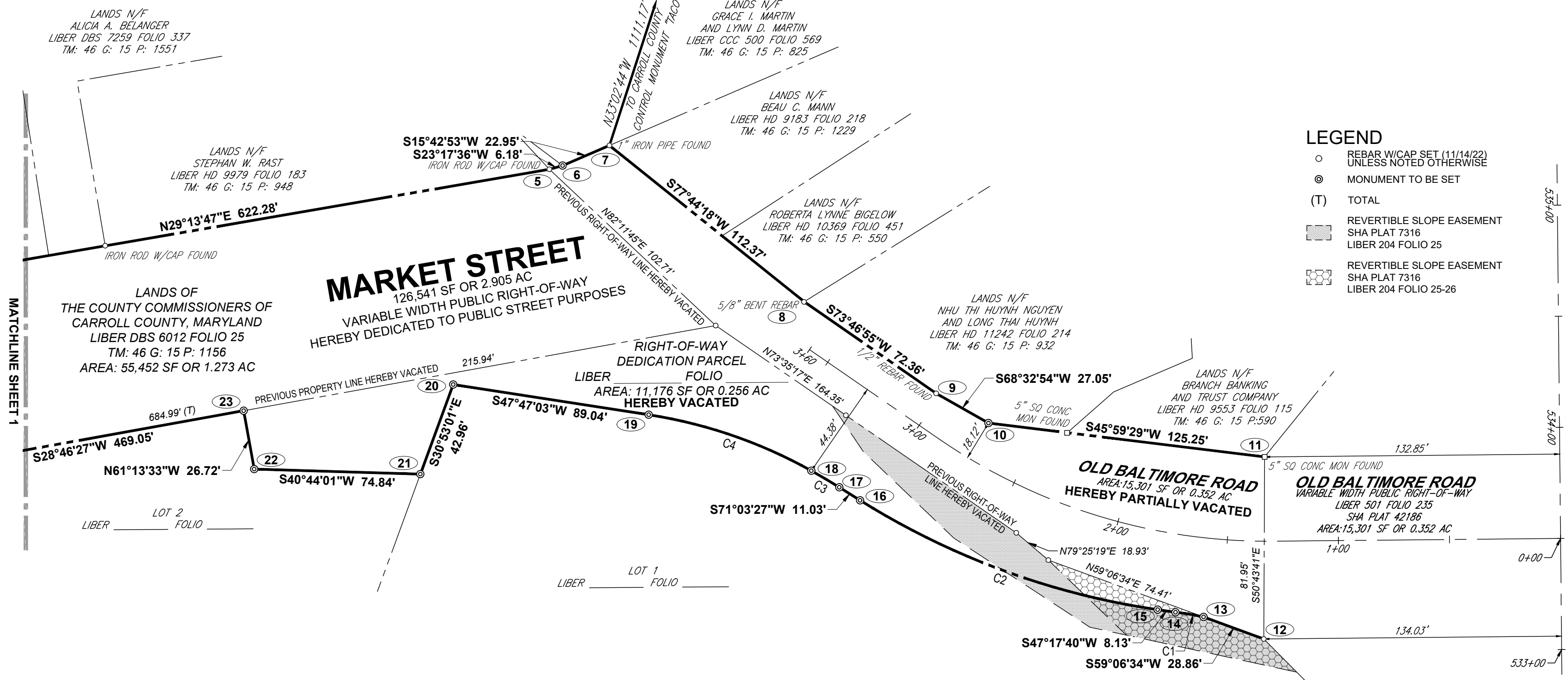

- LEGEND**
- REBAR W/CAP SET (11/14/22)  
UNLESS NOTED OTHERWISE
  - ⊙ MONUMENT TO BE SET
  - (T) TOTAL
  - ▭ REVERTIBLE SLOPE EASEMENT  
SHA PLAT 7316  
LIBER 204 FOLIO 25
  - ▭ REVERTIBLE SLOPE EASEMENT  
SHA PLAT 7316  
LIBER 204 FOLIO 25-26

BALTIMORE BOULEVARD - MD RTE 97 & 140  
150' WIDE PUBLIC RIGHT-OF-WAY  
LIBER 204 FOLIO 25  
LIBER 501 FOLIO 235  
SHA PLAT 42186

2	REVISED PER COUNTY COMMENTS	06/26/2025
1	REVISED PER CLIENT COMMENTS	05/02/2025
No.	DESCRIPTION OF REVISION	DATE

**BOHLER** // 12825 WORLDGATE DRIVE, SUITE 700  
HERNDON, VIRGINIA 20170  
703.709.9500  
www.bohlerengineering.com

UPSTATE NEW YORK ■ BOSTON, MA ■ NEW YORK METRO ■ WARREN, NJ ■ PHILADELPHIA/SOUTHERN NJ ■ LEHIGH VALLEY, PA ■ SOUTHEASTERN PA  
BALTIMORE, MD ■ SOUTHERN MARYLAND ■ NORTHERN VIRGINIA ■ WASHINGTON, DC ■ CENTRAL VIRGINIA ■ CHARLOTTE, NC ■ RALEIGH, NC

**FINAL PLAT**  
THE LANDS OF  
**THE COUNTY COMMISSIONERS OF  
CARROLL COUNTY, MARYLAND**  
LIBER DBS 5266 FOLIO 105  
LIBER 10997 FOLIO 204  
TM: 46 G: 15 P: 1156  
LIBER DBS 5342 FOLIO 186  
TM: 46 G: 15 P: 593  
LIBER DBS 6012 FOLIO 25  
TM: 46 G: 15 P: 1156  
AND  
**BALTIMORE BLVD REALTY, LLC**  
LIBER HD 11130 FOLIO 89  
TM: \_\_\_ G: \_\_\_ P: \_\_\_  
7TH ELECTION DISTRICT  
CARROLL COUNTY, MARYLAND  
CARROLL COUNTY FILE NO. AP- \_\_\_\_\_

DRAWN BY: ID	SCALE: 1" = 40'	PROJECT NO: MDA220021.01
CHECKED BY: EB	DATE: APRIL 30, 2025	2 OF 2
APPROVED: JB		

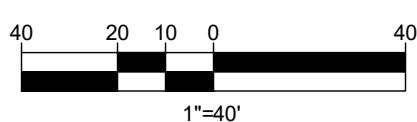

ROBERT C. HARR, JR., PROFESSIONAL LAND SURVEYOR  
MARYLAND REGISTRATION No. 21587  
EXP. JANUARY 16, 2027

DATE





**PLANNING AND ZONING COMMISSION**

February 19, 2026

**TITLE:** **Boot Barn Increased Sign Area, 20 Englar Road**

**REQUEST:** **Sign Permit 2014 - Boot Barn**

The Applicant is requesting Sign Permit Application Approval for two building mounted signs that are each greater than 64 square feet and up to but not exceeding 125 square feet as a tenant sign for Boot Barn at 20 Englar Road, the Westminster Shopping Center.

**PROJECT INFORMATION:**

**LOCATION:** 20 Englar Road, Westminster, Maryland 21158

**ZONE:** B Business Zone

**APPLICANT/REPRESENTATIVES:**

**APPLICANT:** Ryan Drury  
Pacific Neon

**STAFF:** Joe Adkins, AICP, City Planner  
Mark A. Depo, Director of Community Planning and Development

**RECOMMENDATION:** **APPROVAL**

**ATTACHMENTS:**

1. Sign Permit 2014 Application

## STAFF REPORT

Pursuant to City of Westminster Zoning Ordinance (Zoning Ordinance) Article XVII Signs, Section 164-121 A.(5)(a), On-premises business signs, Sign Permit Applications for signs up to and including 125 square feet shall be approved by the Planning and Zoning Commission (“Commission”). In determining whether or not to approve an application, the Commission shall take into consideration the following factors: traffic and pedestrian safety; the size, configuration, elevation and location of the property; existing signs on the property and neighboring properties; aesthetics; and any other factors relating to the location, size, design, composition and specific character of the proposed sign deemed appropriate by the Commission. No sign shall be approved if the Commission finds that it would not achieve a maximum of compatibility, safety, efficiency and attractiveness. The Commission shall approve, approve subject to conditions, or disapprove the Sign Permit Application.

### VICINITY MAP/LOCATION:

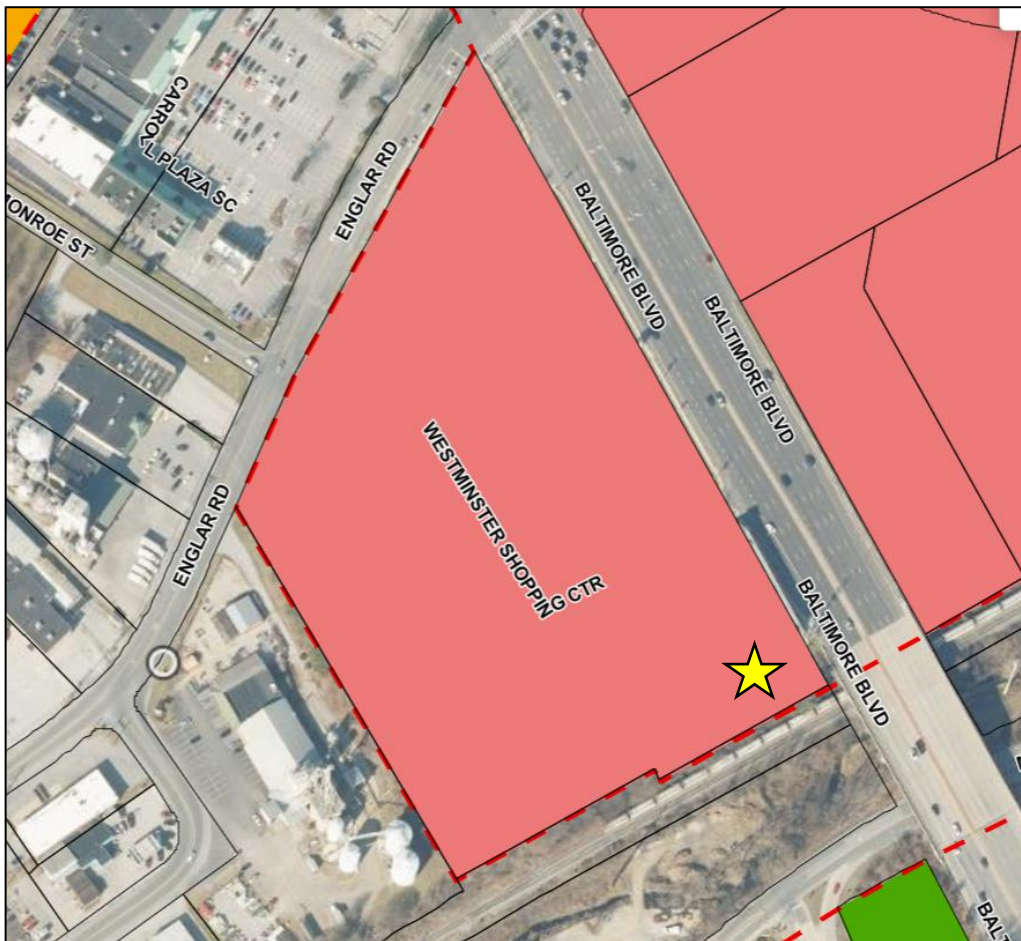

The subject property, 20 Englar Road Westminster, Maryland (SDAT #07-035586) hereinafter referred to as the “Property”, is zoned B Business Zone (Zoning Ordinance Article VIII) and is subject to the Zoning Ordinance. According to SDAT, the Property is approximately 10.8 acres.

## DEVELOPMENT INFORMATION:

The City received Sign Permit 2014 application submitted by Ryan Drury of Pacific Neon Company for a new business, Boot Barn, at the Property. Sign Permit 2014 proposes four building mounted signs. Two of the four building mounted signs are each proposed to be **124.5 square feet** (4 feet in height x 31.125 feet) in size. The linear frontage of the store front is 104.75 feet, which allows for a **total of 314.25 square feet of signage**. The four proposed building mounted signs, including the two 124.5 square feet signs, equals **279 square feet**. Therefore, the total amount of remaining square footage for any additional building mounted, window, or other type of sign is **35.25 square feet**. All four signs are individual channel letters with internal illumination and at night will be illuminated white.

### North Elevation – Facing the Parking Lot



EXISTING ELEVATION

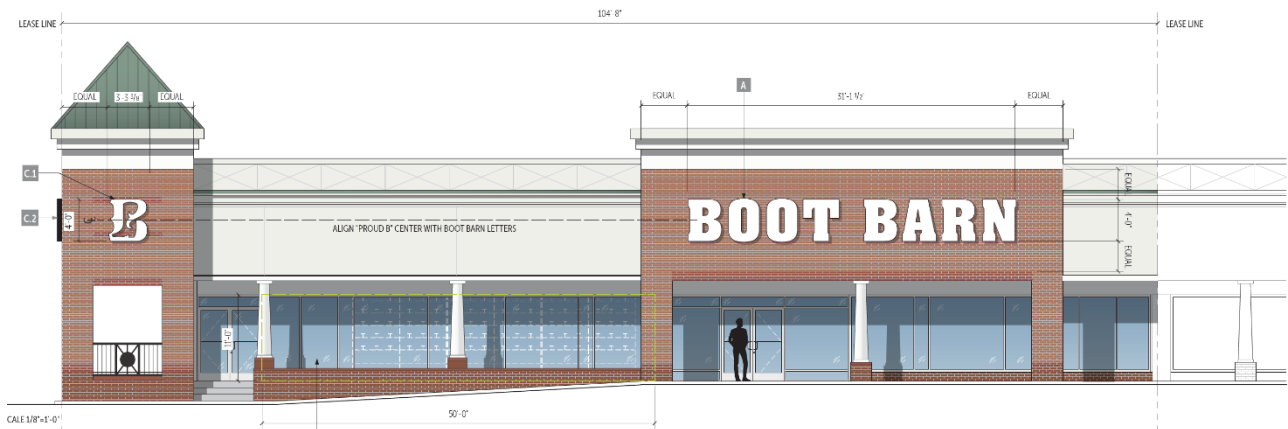

East Elevation – Facing Baltimore Boulevard (MD Route 140)



EXISTING ELEVATION



Pursuant to Zoning Ordinance Section 164-118, Compliance required, “No sign may be erected in any zone, nor a permit issued therefor, unless such sign is specifically permitted by this article and complies with all of the requirements of this chapter [Article XVII, Signs].” Pursuant to Zoning Ordinance Section 164-121.A., “Business signs pertaining to a use on the premises are permitted as an accessory use in the Business Zone” provided that the signs meet the provisions of Section 164-121.A. Pursuant to Zoning Ordinance Section 164-121.A., signs greater than 64 square feet and up to but not exceeding 125 square feet must be approved by the Commission. As described and illustrate, the proposed building mounted signs are both 124.5 square feet, which is greater than 64 square feet does not exceed 125 square feet and falls under the purview of the Commission to review for approval.

**COMMISSION’S FACTORS OF CONSIDERATION**

The Commission shall take into consideration the following factors: safety; the size, configuration, elevation and location of the property; existing signs on the property and neighboring properties;

aesthetics; and any other factors relating to the location, size, design, composition and specific character of the proposed sign deemed appropriate by the Commission. No sign shall be approved if the Commission finds that it would not achieve a maximum of compatibility, safety, efficiency and attractiveness. [Zoning Ordinance Section 164-121.A(5)(a)]

Due to the signs being building mounted and the location of the sign on the building, the Zoning Administrator finds there are pedestrian safety concerns. However, the Zoning Administrator is concerned with such a large sign illuminated at night facing MD Route 140. The side of the building along MD Route 140 abuts the MD Route 140 right-of-way and a 124.5 square foot sign with 4 feet tall letters illuminated white may cause vehicular safety issues. In addition, the Zoning Administrator is concerned with the attractiveness and new standard proposed for signage along MD Route 140. The Zoning Administrator is not aware of any other illuminated building mounted sign in the City that is located on a building that abuts the MD Route 140 right-of-way, particularly a sign larger than 64 square feet.

**RECOMMENDATION:**

DCPD recommends the Commission consider conditional approval of the Sign Permit 2014 to allow two building mounted signs of 124.5 square feet for Boot Barn at 20 Englar Road, subject to:

1. The building mounted sign located along MD Route 140 being non-illuminated channel letters or halo/reverses illuminated channel letters which are individual letters raised from the building wall, with lights inside casting a glow (halo) against the building surface.

**DRAFT MOTIONS FOR SIGN PERMIT 2008-APPROVAL**

1. I move that the Planning and Zoning Commission conditionally approve Sign Permit 2014 to allow two building mounted signs of 124.5 square feet each at 20 Englar Road, Westminster, Maryland, subject to one condition, as outlined in the staff report.

OR

2. I move that the Planning and Zoning Commission deny Sign Permit 2014, not allowing two building mounted signs of 124.5 square feet each at 20 Englar Road, Westminster, Maryland, as outlined in the staff report.

OR

3. I move an alternate motion.

# BOOT BARN®

#1601 Westminster, MD

20 Englar Road | Westminster, MD 21157

Project: 260050-01

Date: 02.02.2026

## Index

- 01 Cover Page
- 02 Site Plan
- 03 North Elevation
- 04 West Elevation
- 05 A Sign Specifications
- 06 B Sign Specifications
- 07 C.1.C.2 Sign Specifications
- 08 D Tenant Panel

Ryan Drury  
(916) 213.8223  
ryan@pacificneon.com

2939 Academy Way  
Sacramento, California 95815

Tel: 916.927.0527 / 800.927.4762  
e-mail: sales@pacificneon.com  
www.pacificneon.com

**PACIFIC  
NEON CO.**

SHEET NUMBER

**01**

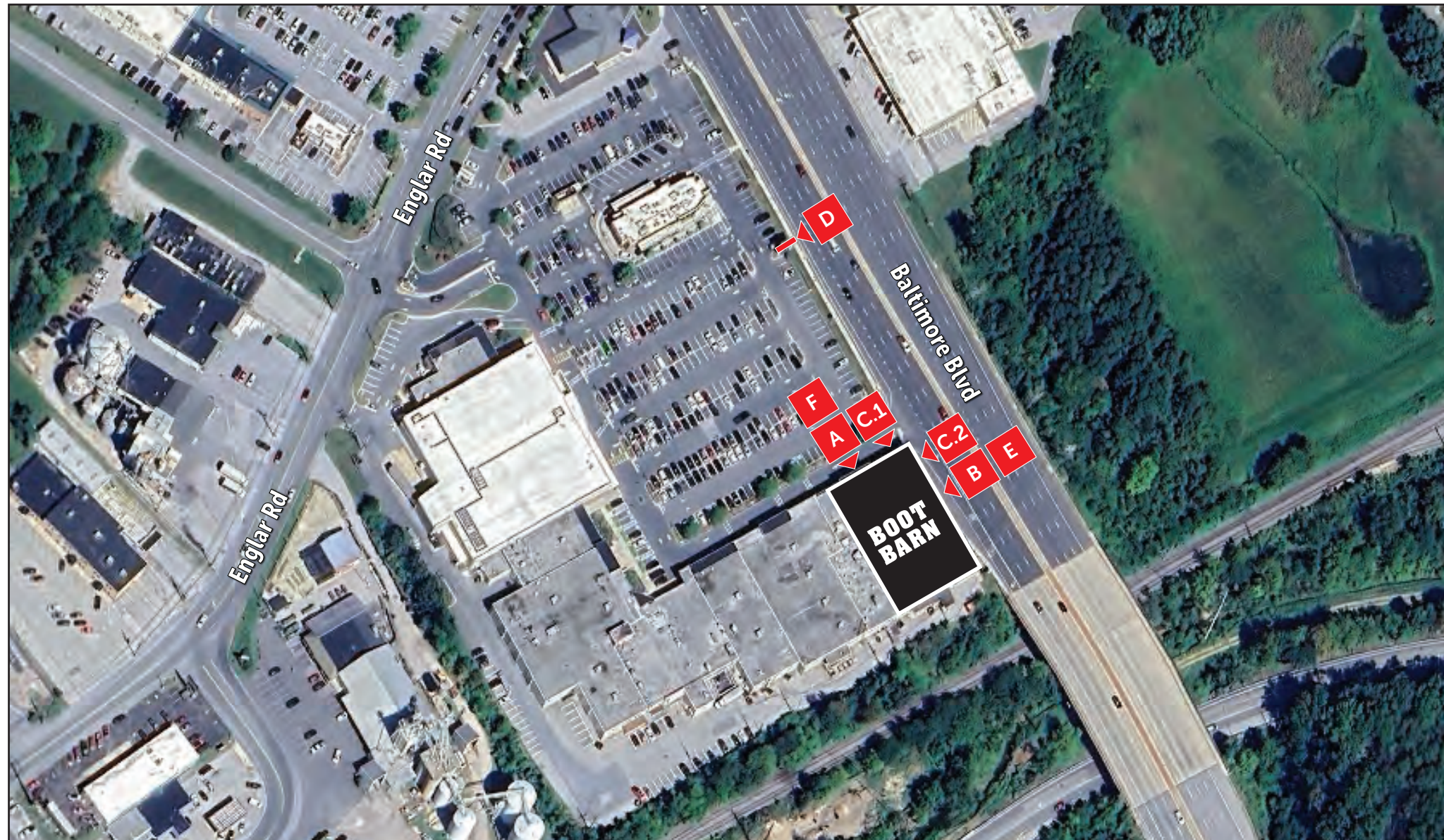

**U.L. Listed**

Signs manufactured to U.L. specifications and bearing the U.L. Label(s) are intended for installation in accordance with the requirements of Article 600 of the National Electrical Code and/or other applicable local codes. This includes proper grounding and bonding of the sign.

**Electrical Circuits**

The customer is required to provide primary dedicated electrical circuit(s) with a separate ground connection to the electrical panel. LED Electronics require a separate dedicated 120V complete circuit (without sharing the neutral wire). A common ground connection to the electrical panel is acceptable.

**California Title 24 Compliant**

**Color Reference**

Actual color may vary from the on-screen representation or presentation material. To verify your color selections, please refer to a physical color chip, production sample, or Pantone® reference guides.

**Copyright ©2026**

All print and electronic art remains the sole, copyrighted property of Pacific Neon Company and is not to be distributed, copied, e-mailed, or transferred in any way without prior written release from Pacific Neon Company.

NORTH ELEVATION

A C.1 F

SIGN AREA CALCULATION 3:1

FRONTAGE 104.67 FT X 3 = 314 SQFT ALLOWED SIGN AREA

PROPOSED FRONT SIGN AREA 139.5 SQFT  
 PROPOSED SIDE SIGN AREA 139.5 SQFT

TOTAL PROPOSED SIGN AREA 279 SQFT



EXISTING ELEVATION

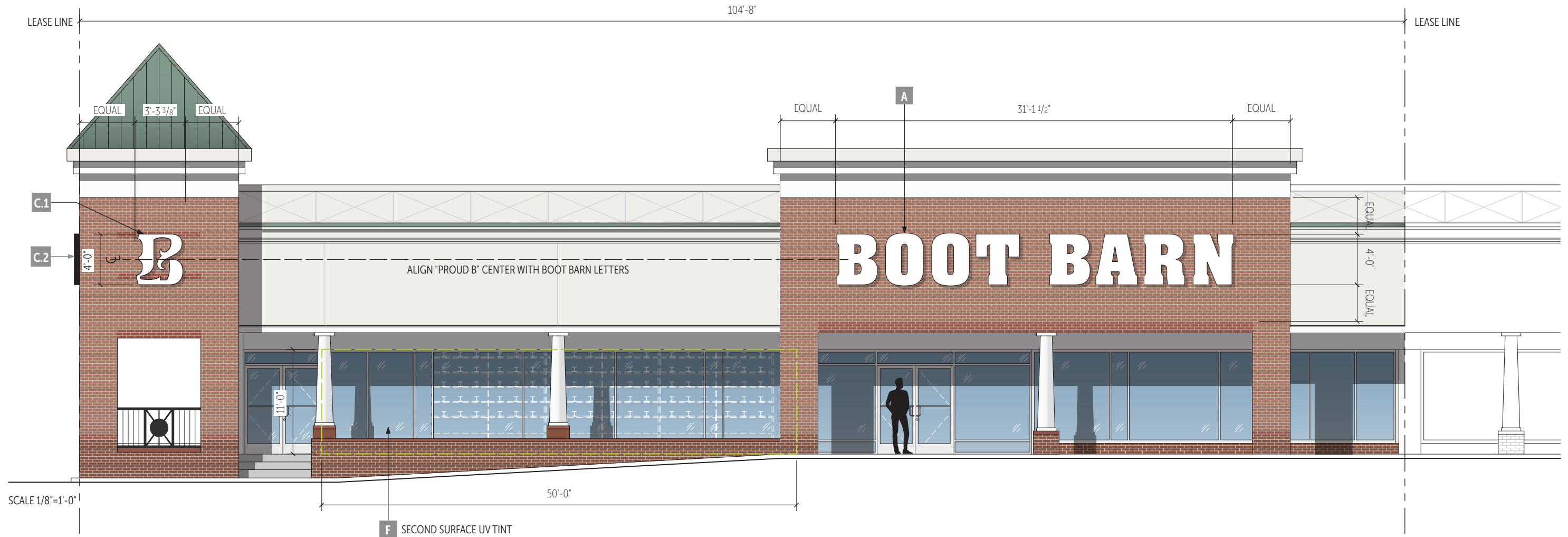

**PACIFIC NEON CO.**

Ryan Drury  
 (916) 213.8223  
 ryan@pacificneon.com

2939 Academy Way  
 Sacramento, California 95815

Tel: 916.927.0527 / 800.927.4762  
 e-mail: sales@pacificneon.com  
 www.pacificneon.com

Project No:  
**260050-01**

Project:  
**Boot Barn #1601 Westminster**

Address:  
**20 Englar Road  
 Westminster MD 21157**

Date:  
**01.15.2026**

Revision 1: **01.21.2026**  
 Revision 2:  
 Revision 3:

**U.L. Listed**

Signs manufactured to U.L. specifications and bearing the U.L. Label(s) are intended for installation in accordance with the requirements of Article 600 of the National Electrical Code and/or other applicable local codes. This includes proper grounding and bonding of the sign.

**Electrical Circuits**

The customer is required to provide primary dedicated electrical circuit(s) with a separate ground connection to the electrical panel. LED Electronics require a separate dedicated 120V complete circuit (without sharing the neutral wire). A common ground connection to the electrical panel is acceptable.

**California Title 24 Compliant**

**Color Reference**

Actual color may vary from the on-screen representation or presentation material. To verify your color selections, please refer to a physical color chip, production sample, or Pantone® reference guides.

**Copyright ©2026**

All print and electronic art remains the sole, copyrighted property of Pacific Neon Company and is not to be distributed, copied, e-mailed, or transferred in any way without prior written release from Pacific Neon Company.

SHEET NUMBER

**03**

EAST ELEVATION

**B** **C.2** **E**

SIGN AREA CALCULATION 3:1	
FRONTAGE	104.67 FT X 3 = 314 SQFT ALLOWED SIGN AREA
PROPOSED FRONT SIGN AREA	139.5 SQFT
PROPOSED SIDE SIGN AREA	139.5 SQFT
TOTAL PROPOSED SIGN AREA	279 SQFT



EXISTING ELEVATION

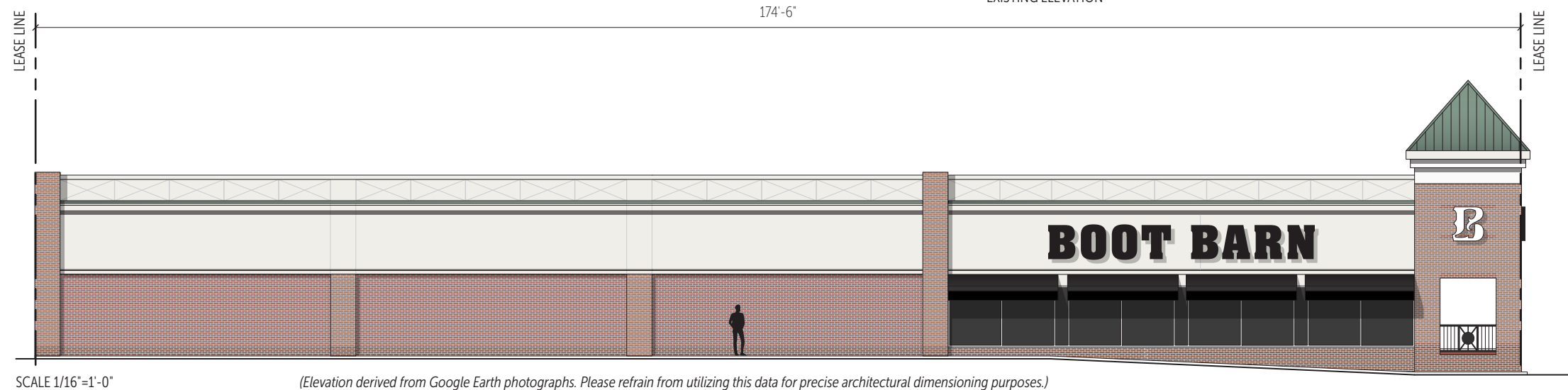

SCALE 1/16"=1'-0"

(Elevation derived from Google Earth photographs. Please refrain from utilizing this data for precise architectural dimensioning purposes.)

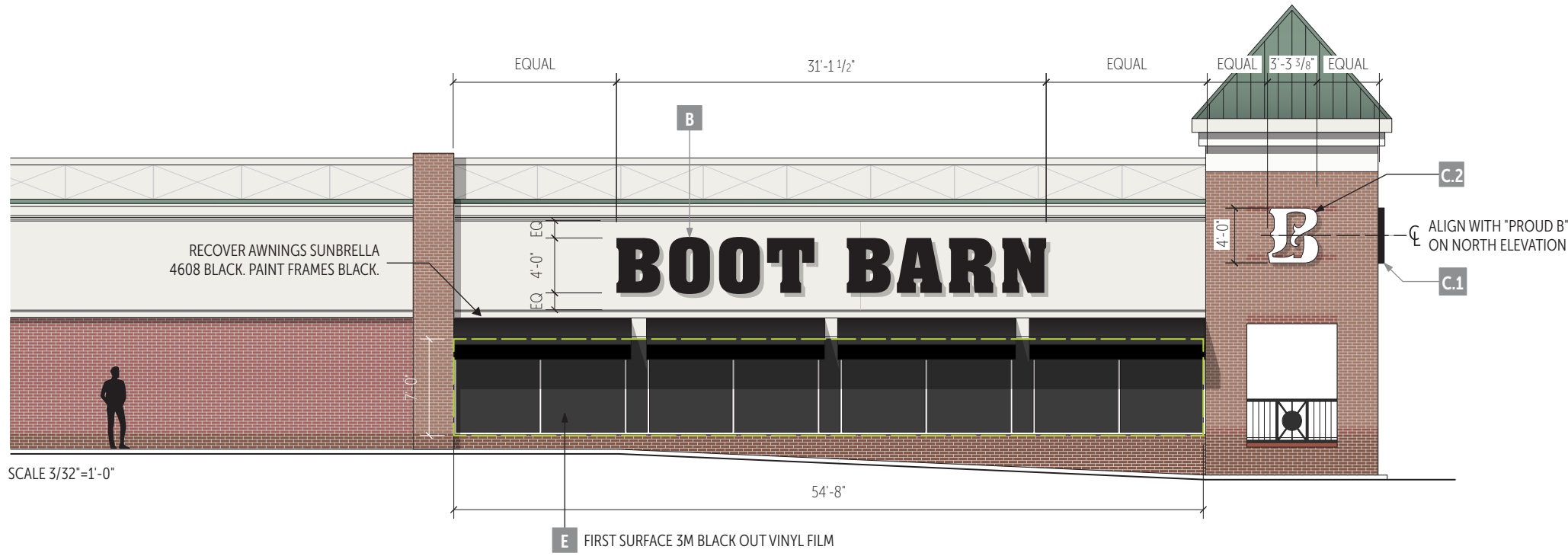

SCALE 3/32"=1'-0"

**PACIFIC NEON CO.**  
 Ryan Drury  
 (916) 213.8223  
 ryan@pacificneon.com  
 2939 Academy Way  
 Sacramento, California 95815  
 Tel: 916.927.0527 / 800.927.4762  
 e-mail: sales@pacificneon.com  
 www.pacificneon.com

Project No:  
**260050-01**  
 Project:  
**Boot Barn #1601 Westminster**  
 Address:  
**20 Englar Road  
 Westminster MD 21157**

Date:  
**01.15.2026**  
 Revision 1: **01.21.2026**  
 Revision 2: **02.02.2026**  
 Revision 3:

**U.L. Listed**  
 Signs manufactured to U.L. specifications and bearing the U.L. Label(s) are intended for installation in accordance with the requirements of Article 600 of the National Electrical Code and/or other applicable local codes. This includes proper grounding and bonding of the sign.  
**Electrical Circuits**  
 The customer is required to provide primary dedicated electrical circuit(s) with a separate ground connection to the electrical panel. LED Electronics require a separate dedicated 120V complete circuit (without sharing the neutral wire). A common ground connection to the electrical panel is acceptable.

California Title 24 Compliant  
**Color Reference**  
 Actual color may vary from the on-screen representation or presentation material. To verify your color selections, please refer to a physical color chip, production sample, or Pantone® reference guides.  
**Copyright ©2026**  
 All print and electronic art remains the sole, copyrighted property of Pacific Neon Company and is not to be distributed, copied, e-mailed, or transferred in any way without prior written release from Pacific Neon Company.

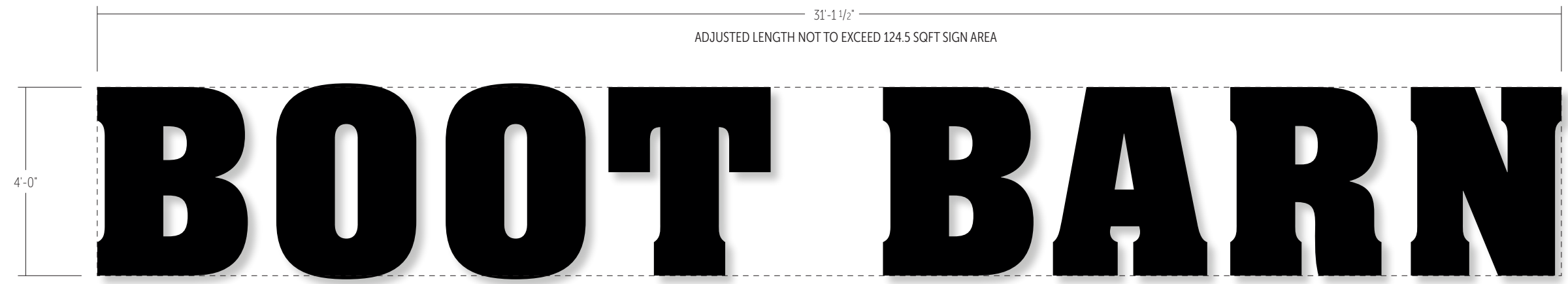

**SPECIFICATIONS**

SCALE 3/8"=1'-0" | SIGN AREA 124.5 SF

RETURNS: PRE-PAINTED BLACK 5" DEEP ALUMINUM

FACES: #015 WHITE ACRYLIC FACES

TRIM CAP: 1" BLACK

ILLUMINATION: WHITE LED ILLUMINATION.

**COLORS & MATERIALS**

- PRE-FINISHED BLACK ALUMINUM AND TRIMCAP.
- #015 WHITE ACRYLIC.

**EXPANDED LETTER DETAIL**

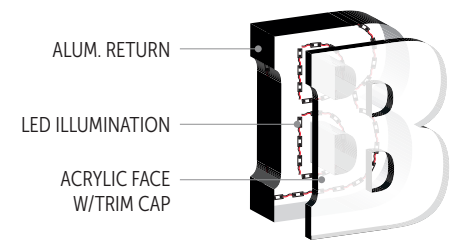

**DAY / NIGHT ILLUMINATION**

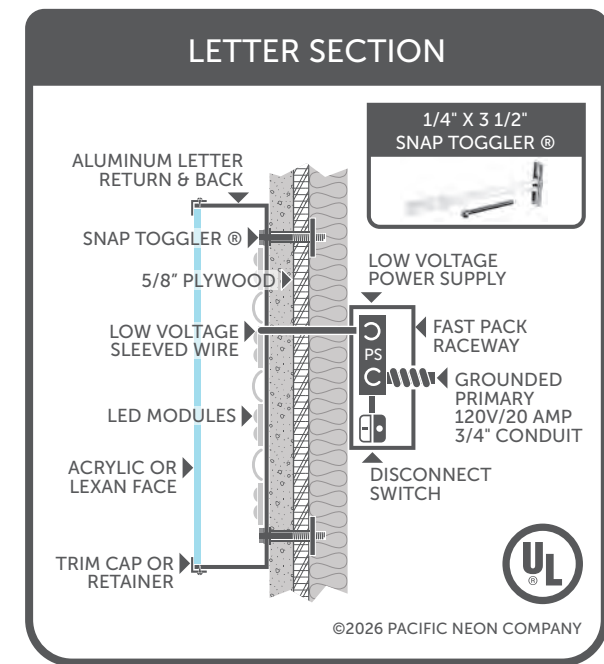
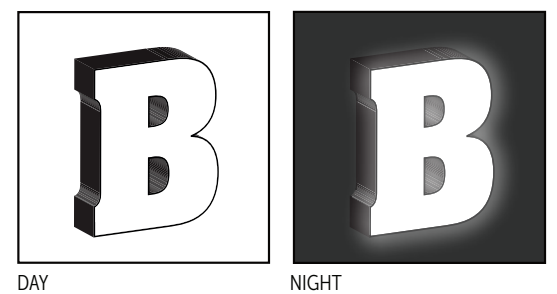

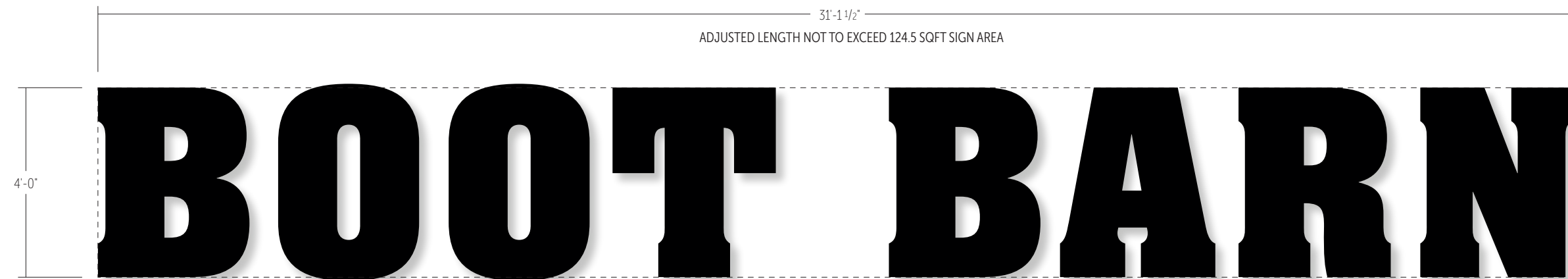



**SPECIFICATIONS**

SCALE 3/8"=1'-0" | SIGN AREA 124.5 SF

- RETURNS: PRE-PAINTED BLACK 5" DEEP ALUMINUM
- FACES: #020 WHITE ACRYLIC FACES
- TRIM CAP: 1" BLACK
- VINYL FILM: PERFORATED BLACK VINYL FILM APPLIED FIRST SURFACE
- ILLUMINATION: WHITE LED ILLUMINATION.

**COLORS & MATERIALS**

-  PRE-FINISHED ALUMINUM AND TRIMCAP GLOSS BLACK.
-  #020 WHITE ACRYLIC.
-  BLACK PERFORATED VINYL FILM

**EXPANDED LETTER DETAIL**

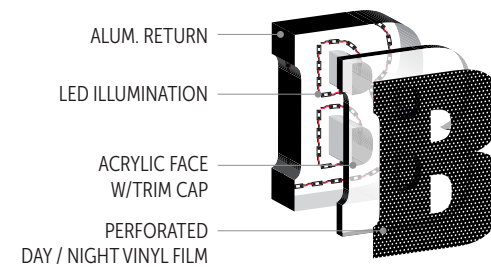

**DAY / NIGHT ILLUMINATION**

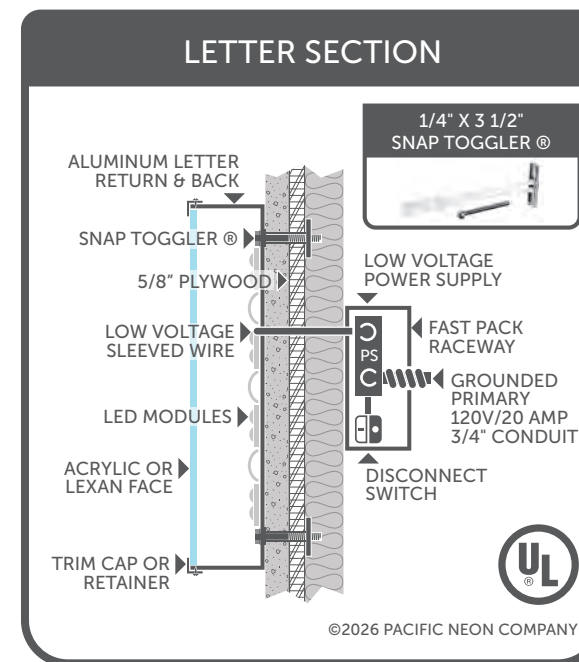
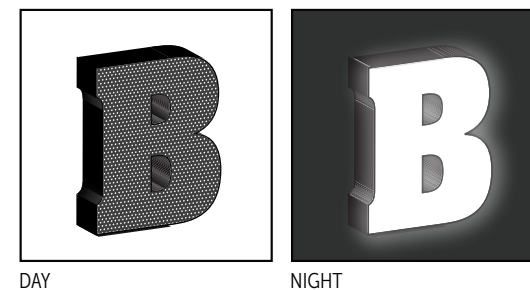

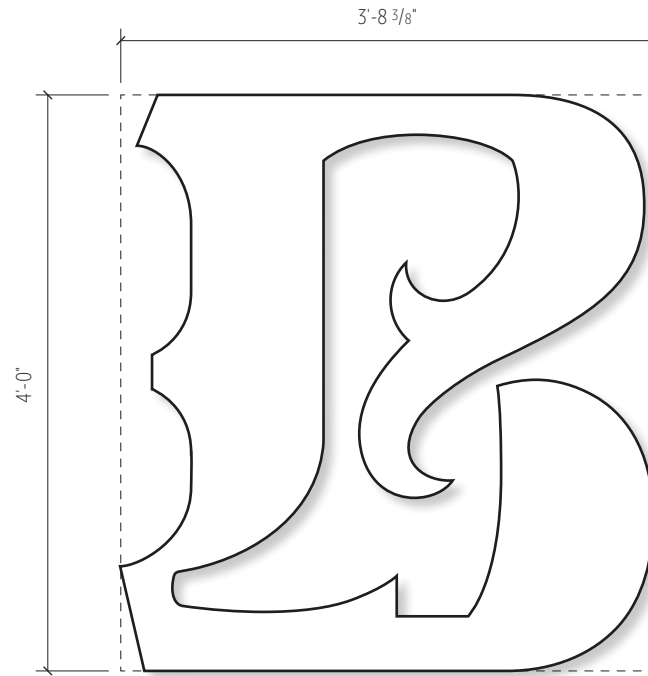

**SPECIFICATIONS**

SCALE 3/4"=1'-0" | SIGN AREA 15 SF

- RETURNS: PRE-PAINTED BLACK 5" DEEP ALUMINUM
- FACES: #015 WHITE ACRYLIC FACES
- TRIM CAP: 1" BLACK
- ILLUMINATION: WHITE LED ILLUMINATION.

**COLORS & MATERIALS**

- PRE-FINISHED BLACK ALUMINUM AND TRIMCAP.
- #015 WHITE ACRYLIC.

**EXPANDED LETTER DETAIL**

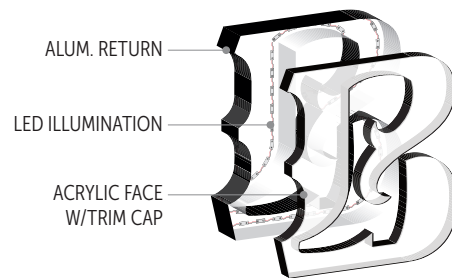

**DAY / NIGHT ILLUMINATION**

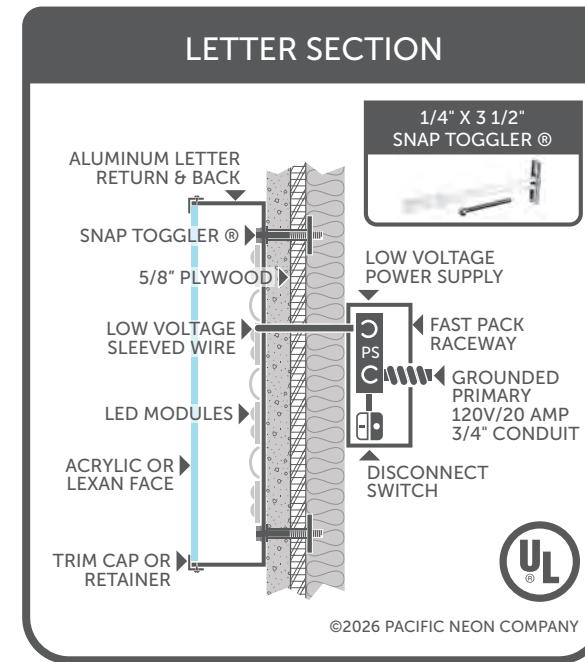
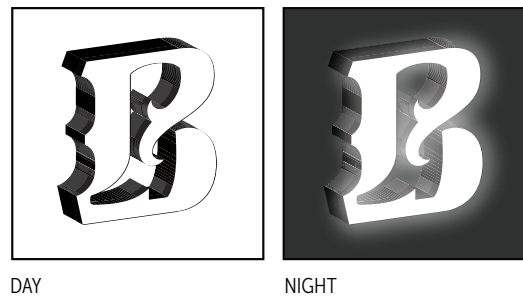



EXISTING ELEVATION



PROPOSED TENANT PANEL | BOOT BARN TO BE ON BOTH SIDES OF THE SIGN



**SPECIFICATIONS**

SCALE 1/2"=1'-0" | SIGN AREA 24 SF

FACES: WHITE LEXAN

VINYL FILM: 3M 3630-22 BLACK VINYL FILM

**COLORS & MATERIALS**

 3M 3630-22 BLACK VINYL FILM.

 WHITE LEXAN.

**U.L. Listed**

Signs manufactured to U.L. specifications and bearing the U.L. Label(s) are intended for installation in accordance with the requirements of Article 600 of the National Electrical Code and/or other applicable local codes. This includes proper grounding and bonding of the sign.

**Electrical Circuits**

The customer is required to provide primary dedicated electrical circuit(s) with a separate ground connection to the electrical panel. LED Electronics require a separate dedicated 120V complete circuit (without sharing the neutral wire). A common ground connection to the electrical panel is acceptable.

**California Title 24 Compliant**

**Color Reference**

Actual color may vary from the on-screen representation or presentation material. To verify your color selections, please refer to a physical color chip, production sample, or Pantone® reference guides.

**Copyright ©2026**

All print and electronic art remains the sole, copyrighted property of Pacific Neon Company and is not to be distributed, copied, e-mailed, or transferred in any way without prior written release from Pacific Neon Company.



To: Planning and Zoning Commission

From: Mark A. Depo, Director of Community Planning and Development

Meeting Date: February 19, 2025

Re: **Zoning Map Amendment ZMA 24-01 Work Session on Architectural Elevations**

### ZONAL CLASSIFICATION REQUEST

D.R. Acquisitions, LLC (the "Applicant"), submitted a request and concept development plan and architectural elevations for The Willows (hereafter "Development Plan") to amend the Zoning Map to reclassify certain real property located in the City of Westminster from the R-7,500 Residential Zone (R-7,500 Zone).

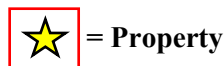
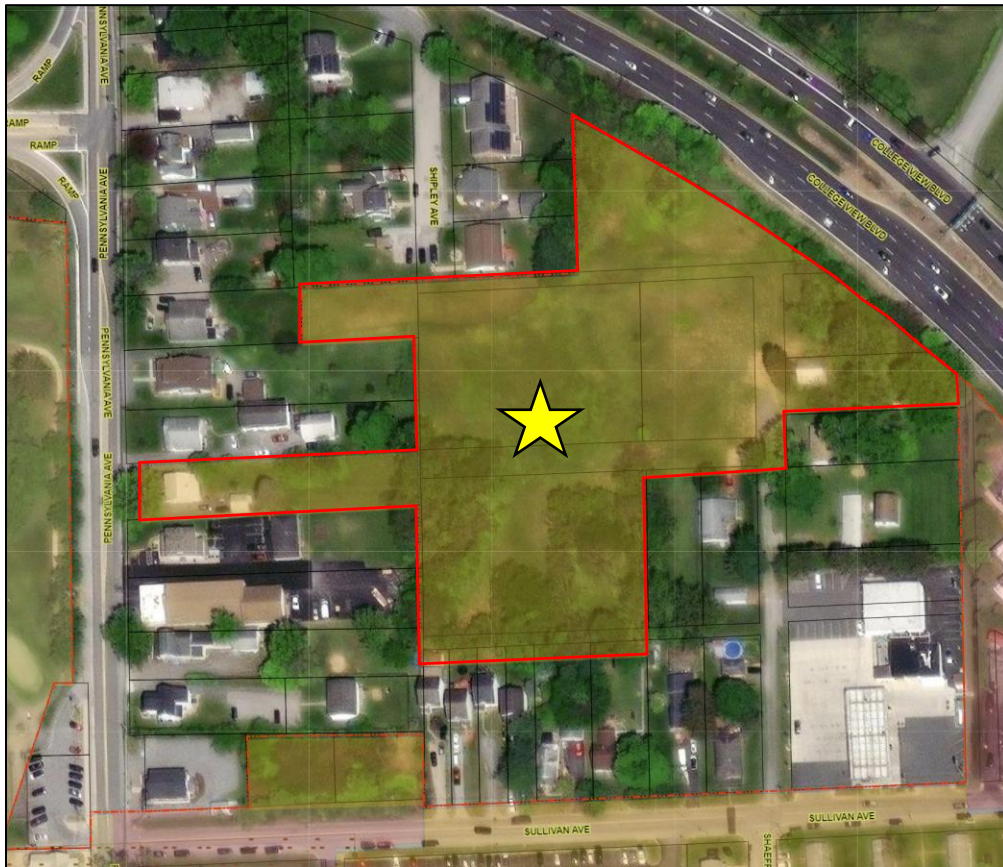

## **RECOMMENDATION**

The Department of Community Planning and Development (DCPD) is requesting the City of Westminster Planning and Zoning Commission (PZC) review and approve, conditionally approve, or provide further input for a future meeting the architectural elevations for the proposed Willows development, Zoning Map Amendment ZMA 24-01.

## **ATTACHMENTS**

1. December 17, 2025 Commission Meeting Architectural Elevation Examples
2. Updated Architectural Elevations



**Option 1 - Front View**

**Option 1 - Side View**

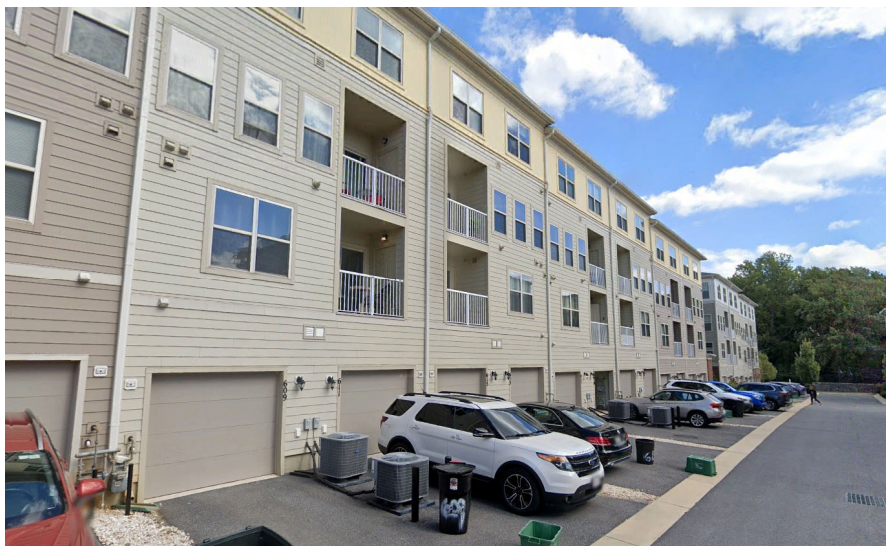

**Option 1 - Rear View**

**LOCATION**

Diamondback Dr Gaithersburg, MD



## Option 2 - Front View

(no garage in front)

## Option 2 - Side View

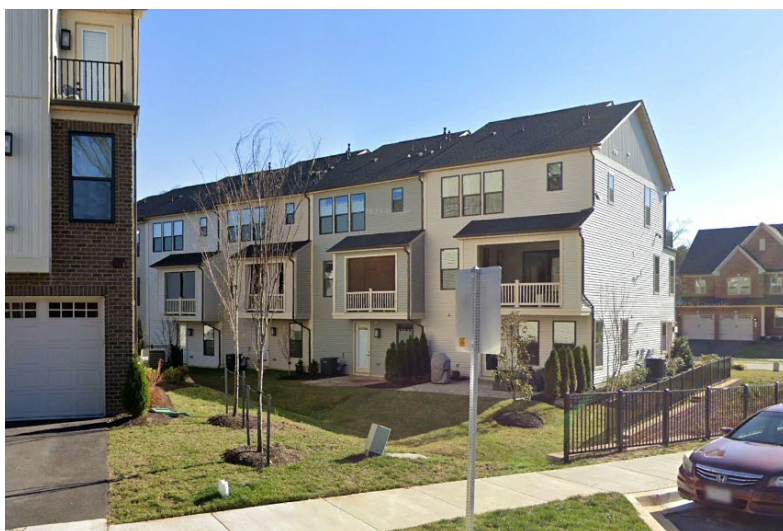

## Option 2 - Rear View

### LOCATION

7203 Mainstream Way, Columbia, MD 21044

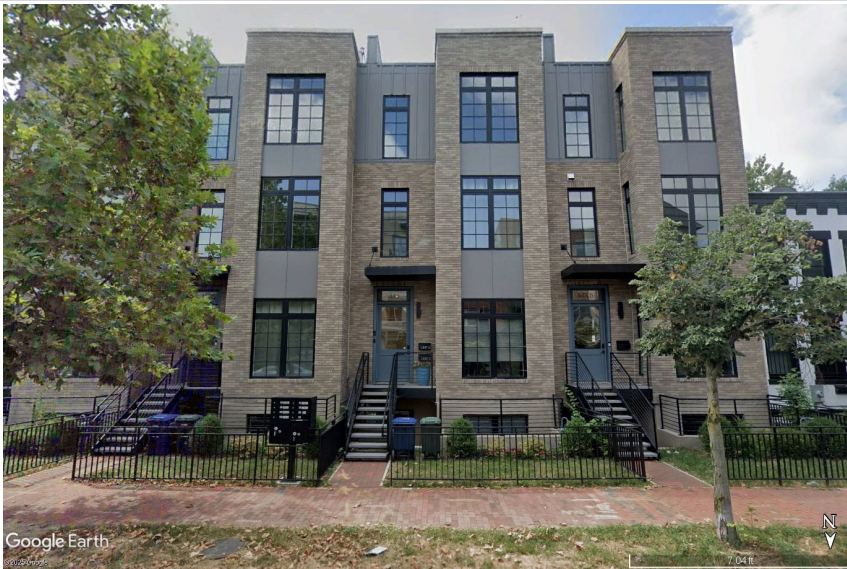

**Option 3 - Front View**

**Option 3 - Side View**



**LOCATION**

440 R Street Unit B NW Washington, D.C. 20001



**Option 4 - Front View**

**Option 4 - Side View**



**Option 4 - Rear View**

**LOCATION**

156 Winsome Circle, Bethesda, MD



**Option 5 - Front View**



**Option 5 - Side View**



**Option 5 - Rear View**

**LOCATION**

Blair Markham ST, Nashville, TN 37214



**Option 6** - Front View



**Option 6** - Side View



**Option 6** - Front View

**LOCATION**

15 William Jackson Way Toronto, ON



**Option 7 - Front View**

**Option 7 - Enlarged View**

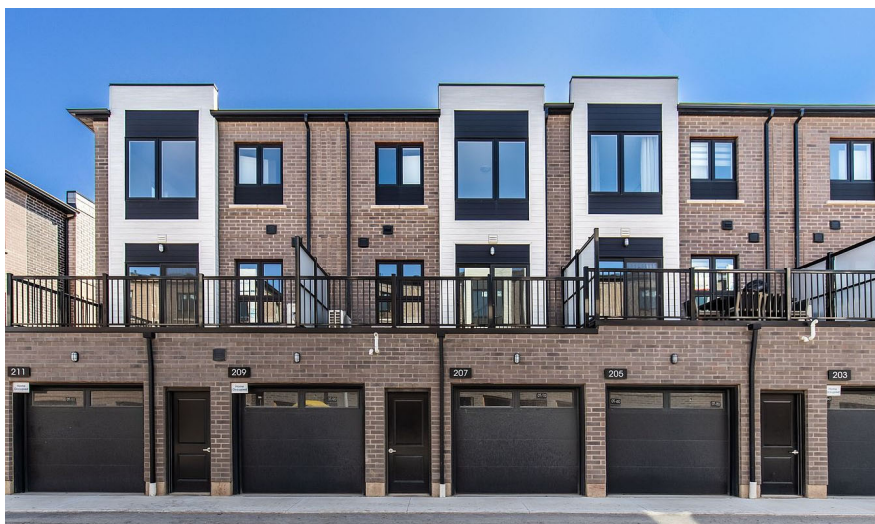

**Option 7 - Rear View**

**LOCATION**

199 Burke St, Hamilton, ON



**Option 8** - Front View

**Option 8** - Single Townhome View



**Option 8** - Two Townhome View

**LOCATION**

5685 14th Ave Markham, ON

## Option 9 - Front View (color scheme A)



## Option 9 - Front View (color scheme B)



### LOCATION

11678 Mclaughlin Lane Caledon, ON

## Option 10 - Front View



## Option 10 - Rear View



### LOCATION

1025 Wedgewood Ave, Nashville, TN 37203

## Option 11 - Front View



## Option 11 - Rear View

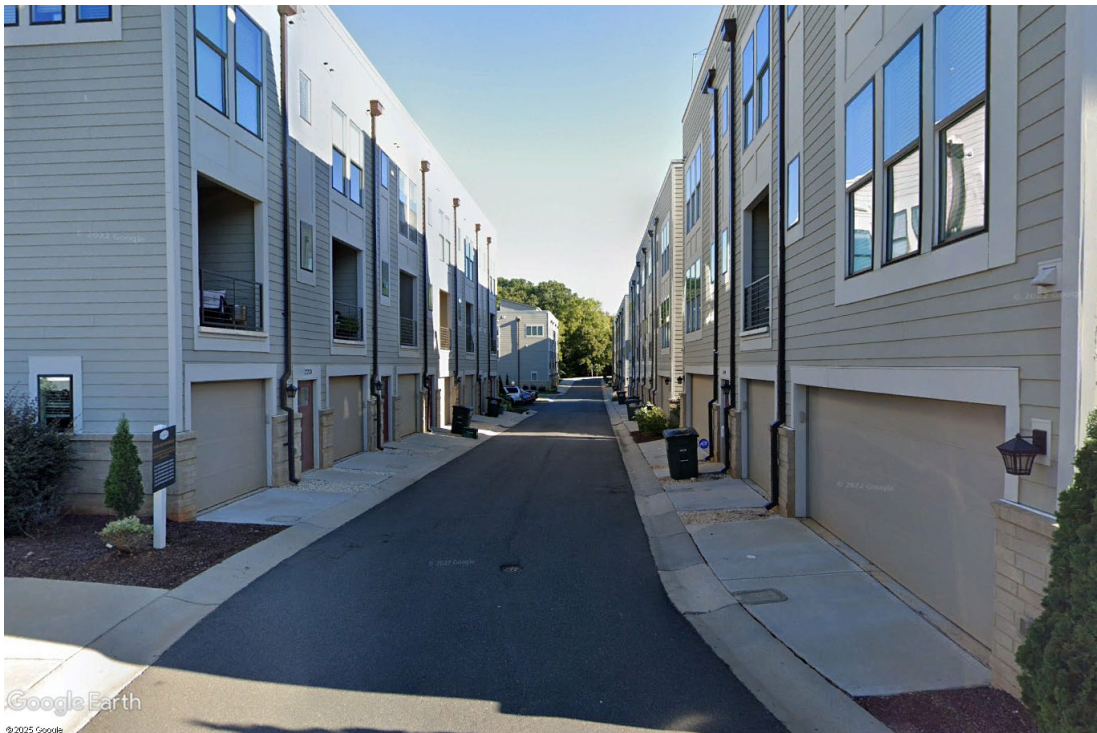

### LOCATION

240 Uptown W Dr Charlotte NC

## Option 12 - Front View



## Option 12 - Rear View



### LOCATION

3111 Runnymede Lane Charlotte, NC

## Option 13 - Front View



## Option 13 - Rear View



### LOCATION

463 Blairhill Rd Charlotte, NC 28217



**Option 14**



**Option 15**



**Option 16**



**Option 17**

**LOCATION**

Varies



THESE PLANS AND DRAWINGS ARE NOT TO BE REPRODUCED, CHANGED, OR COPIED IN ANY FORM OR MANNER WHATSOEVER, WITHOUT FIRST OBTAINING THE EXPRESS WRITTEN PERMISSION AND CONSENT OF ZAVOS ARCHITECTURE + DESIGN, LLC. NOR ARE THEY TO BE ASSIGNED TO ANY THIRD PARTY WITHOUT FIRST OBTAINING SAID WRITTEN PERMISSION AND CONSENT.

COPYRIGHT 2025 © ZAVOS ARCHITECTURE + DESIGN, LLC.

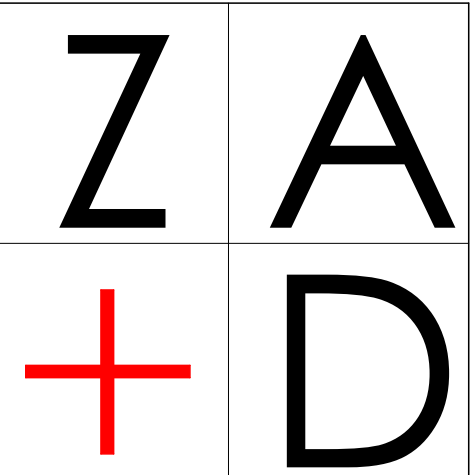

The Willows - Typical Exterior Architecture

OPTION A



The Willows - Typical Exterior Architecture

OPTION A

THESE PLANS AND DRAWINGS ARE NOT TO BE REPRODUCED, CHANGED, OR COPIED IN ANY FORM OR MANNER WHATSOEVER, WITHOUT FIRST OBTAINING THE EXPRESS WRITTEN PERMISSION AND CONSENT OF ZAVOS ARCHITECTURE + DESIGN, LLC. NOR ARE THEY TO BE ASSIGNED TO ANY THIRD PARTY WITHOUT FIRST OBTAINING SAID WRITTEN PERMISSION AND CONSENT.

COPYRIGHT 2025 ©  
ZAVOS ARCHITECTURE + DESIGN, LLC.

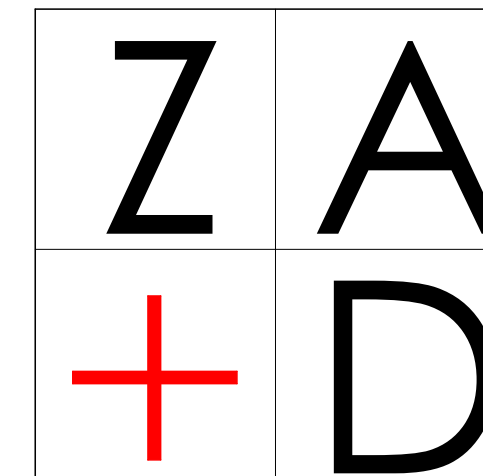

**Z**A+D design  
**Z**A+D interiors  
**Z**A+D passiv  
 Redefining the Building Potential



THESE PLANS AND DRAWINGS ARE NOT TO BE REPRODUCED, CHANGED, OR COPIED IN ANY FORM OR MANNER WHATSOEVER, WITHOUT FIRST OBTAINING THE EXPRESS WRITTEN PERMISSION AND CONSENT OF ZAVOS ARCHITECTURE + DESIGN, LLC. NOR ARE THEY TO BE ASSIGNED TO ANY THIRD PARTY WITHOUT FIRST OBTAINING SAID WRITTEN PERMISSION AND CONSENT.

COPYRIGHT 2025 © ZAVOS ARCHITECTURE + DESIGN, LLC.

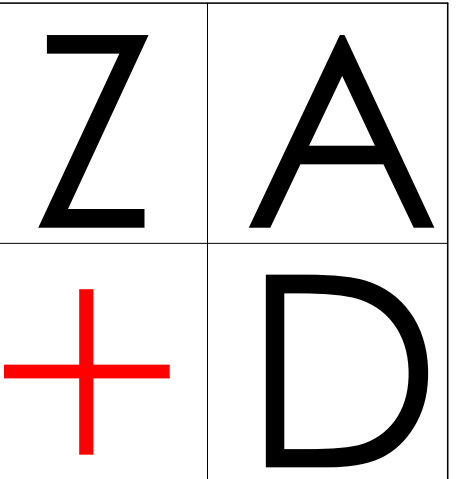

The Willows - Typical Exterior Architecture

OPTION B



THESE PLANS AND DRAWINGS ARE NOT TO BE REPRODUCED, CHANGED, OR COPIED IN ANY FORM OR MANNER WHATSOEVER, WITHOUT FIRST OBTAINING THE EXPRESS WRITTEN PERMISSION AND CONSENT OF ZAVOS ARCHITECTURE + DESIGN, LLC. NOR ARE THEY TO BE ASSIGNED TO ANY THIRD PARTY WITHOUT FIRST OBTAINING SAID WRITTEN PERMISSION AND CONSENT.

COPYRIGHT 2025 © ZAVOS ARCHITECTURE + DESIGN, LLC.

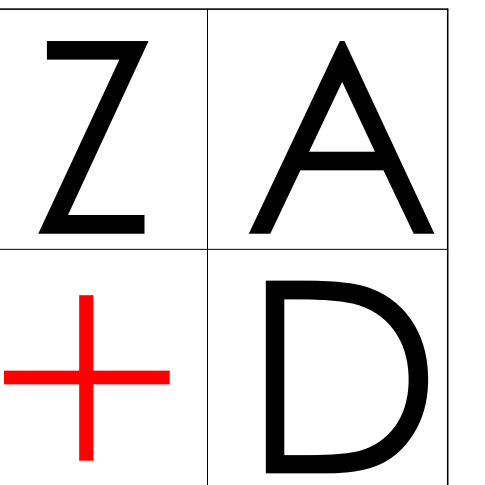

The Willows - Typical Exterior Architecture

OPTION B